



# Epic Enterprises, Inc.

Epic Enterprises, Inc., P.O. Box 979, Southern Pines, NC 28388-0979 USA  
 Telephone Toll Free 800-648-7273 or 910-692-5441 Outside USA  
 Fax: Toll Free 888-692-4147 or 910-692-4147 Outside USA  
 Website: <http://www.epicenterprises.com> E-Mail: [epic@epicenterprises.com](mailto:epic@epicenterprises.com)

## EPIC REPLACEMENT PARTS FOR VERDOL April 2009

VE-1









OEM Part #	Epic No.	Description	Page	
	EE305559	Cot, Friction Roll, Gray, 86X82X2mm, for ICBT CD/DT		EA
				
	EE309137	Rebuild, Customer, ICBT DT-560 Spindle (Motor Driven) - CONTACT EPIC FOR PRICING		EA
000103	EE380142	Grommet, Urethane, for Magnet Plate, Verdol RM, F44 & ICBT	VE18 VE19 VE20	EA
				
021084003	EE340021	Disc and Reserve Assembly, Stainless, 260 X 160mm for RM, F44 and ICBT	VE18 VE19 VE20	EA
				
021084023	EE380162	Axle & Hub Assembly for ICBT N Spindle	VE20	EA
				
(021084023)	EE380160	Axle, ICBT N Spindle	VE20	EA
				
021084024	EE340053	Spindle Assembly, ICBT N, without Housing or Spindle Disc Assembly	VE20	EA
				

EE is an Epic trademark designating Epic parts

Verdol is a trademark of Rieter/ ICBT

© Epic Enterprises, April 2009

Epic products are intended as replacements for worn or damaged parts in OEM products. OEM Part numbers in (parenthesis) indicate either 1) Improved design 2) the part serves the same function as the OEM part, but may differ from the OEM design, or 3) it is a component of an assembly where no OEM reference number is available, or 4) it is a repair service for the referenced OEM part.

<b>OEM Part #</b>	<b>Epic No.</b>	<b>Description</b>	<b>Page</b>	
(021084024)	EE380161	Hub, Axle, ICBT N Spindle	VE20	EA
				
021084028	EE340051	Disc and Reserve Assembly, Stainless, 280 X 200mm, ICBT	VE18 VE19 VE20	EA
				
(021084028)	EE309102	Repair, ICBT or RM/F44 Spindle Disc Assembly, 280X200mm, with New Mounting Hub (EE340050) and Balance	VE18 VE19 VE20	EA
				
(021084028)	EE340048	Repair, of Threading Channel 200mm, and Balance	VE18 VE19 VE20	EA
				
021084047	EE303216	Deflector, Large, for RM, Original Type, 175mm Reserve Discs	VE18 VE19	EA
				
021084048	EE303217	Deflector, Small, for RM, Original Type, 160mm Reserve Discs	VE18	EA
				
021084118	EE380144	Plate, Upper Magnet, with Magnets for Verdol Spindles, RM, F44, & ICBT	VE18 VE19 VE20	EA
				
021085001	EE380146-1	Plate, Magnet, 48mm I.D., with Two Magnets for Verdol 400 Pot Base, R to RM Conversion and ICBT	VE07	EA
				
(021085009)	EE380229	Tube Centering Adaptor for Pot, 73mm, Verdol/ICBT	VE28 VE28A	EA
				

<b>OEM Part #</b>	<b>Epic No.</b>	<b>Description</b>	<b>Page</b>	
021085030	EE380214	Base Shell Assembly with Locking Nut and Magnet Plate Assembly, ICBT, CD-DT		EA
				
021085094	EE380209	Base Shell Assembly, ICBT, CD-DT	VE28 VE28A	EA
				
021085134	EE380213	Base Shell Assembly with Locking Nut, ICBT, CD-DT	VE28 VE28A	EA
				
(021085140)	EE309127	Pot, Customer, Repaired, Stainless Steel Bottom, for 260mm Disc, ICBT, DT/CD	VE28 VE28A	EA
				
(021085197)	EE309129	Pot, Customer, Repaired, Stainless Steel Bottom, for 280mm Disc, ICBT, DT/CD	VE28 VE28A	EA
				
(021085289)	EE309129	Pot, Customer, Repaired, Stainless Steel Bottom, for 280mm Disc, ICBT, DT/CD	VE28 VE28A	EA
				
(021101039)	EE304390	Pulley, Tape Tension (50mm) for Model 450	VE17	EA
				
(021101039)	EE309125	Pulley, Heavy Duty Tape Tension, for ICBT and Verdol 450	VE17	EA
				
021180000	EE305545	Friction Roller Assembly, ICBT and Verdol 450 with Full Length Cot	VE24	EA
				

EE is an Epic trademark designating Epic parts

Verdol is a trademark of Rieter/ ICBT

© Epic Enterprises, April 2009

Epic products are intended as replacements for worn or damaged parts in OEM products. OEM Part numbers in (parenthesis) indicate either 1) Improved design 2) the part serves the same function as the OEM part, but may differ from the OEM design, or 3) it is a component of an assembly where no OEM reference number is available, or 4) it is a repair service for the referenced OEM part.

<b>OEM Part #</b>	<b>Epic No.</b>	<b>Description</b>	<b>Page</b>	
(021180000)	EE309103	Strip Customer Verdol 450 or ICBT Friction Roll and install Full Length Cot EE305542 (Minimum 12 pieces)	VE24	EA
				
021190002	EE380150	Traverse Guide Bracket Assembly, ICBT		EA
				
021230010	EE380207	Balloon Guide Complete, for ICBT, CD-DT		EA
				
(021381037)	EE380175	Pre-Take-Up/Overfeed Assembly, 14 Flute Ceramic Coated, ICBT Type	VE25	EA
				
021381038	EE380175-1	PTU/Overfeed Assembly, 14 Flute, Chrome Plated, ICBT Type	VE25	EA
				
021410008	EE380020	Roller, V-Groove Assembly	VE16 VE22	EA
				
(021410056)	EE340035	Storage Tensor with Bracket Assembly and Roller Assembly for ICBT Creel	VE21	EA
				
(021410056)	EE340035-2A	Dial Storage Tensor for ICBT with Mounting Bracket and Hardware, without Roller	VE21	EA
				
021440048	EE309072	Capsule, Tension #1 for Verdol	VE07	EA
				









OEM Part #	Epic No.	Description	Page	
(021442001)	EE380114-2A	Dial Storage Tensor	VE21	EA
				
032084002	EE340051	Disc and Reserve Assembly, Stainless, 280 X 200mm, ICBT	VE18 VE19 VE20	EA
				
(032084017)	EE309099	Rebuild Customer ICBT CD/DT; N Spindle CONTACT EPIC FOR PRICING	VE04 VE20	EA
				
(032085058)	EE380229	Tube Centering Adaptor for Pot, 73mm, Verdol/ICBT	VE28 VE28A	EA
				
032085097	EE380213	Base Shell Assembly with Locking Nut, ICBT, CD-DT	VE28 VE28A	EA
				
116039	EE301990	Spring, Spindle Tape Tension	VE17	EA
				
116060	EE302000	Spring, E Overhead Creel	VE14	EA
				
117068	EE302040	Spring, Spindle for R, U, & G Spindle (also used for Balloon Centering Guide)	VE01 VE01A VE09 VE18 VE19	EA
				
(117143A00)	EE302040	Spring, Spindle for R, U, & G Spindle (also used for Balloon Centering Guide)	VE01 VE01A VE09 VE18 VE19	EA
				







EE is an Epic trademark designating Epic parts

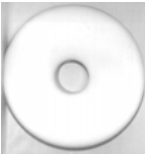

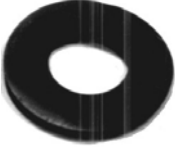

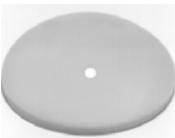

Verdol is a trademark of Rieter/ ICBT

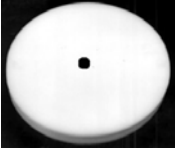
© Epic Enterprises, April 2009

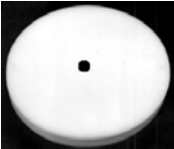
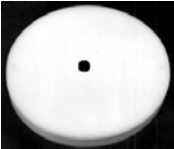

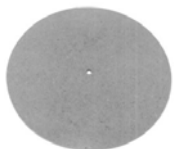
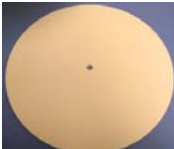





Epic products are intended as replacements for worn or damaged parts in OEM products. OEM Part numbers in (parenthesis) indicate either 1) Improved design 2) the part serves the same function as the OEM part, but may differ from the OEM design, or 3) it is a component of an assembly where no OEM reference number is available, or 4) it is a repair service for the referenced OEM part.









<b>OEM Part #</b>	<b>Epic No.</b>	<b>Description</b>	<b>Page</b>	
119000	EE302060	Washer, Large Rubber for 400 Base Shell and ICBT Base Shell	VE05A VE07 VE28 VE28A	EA 
119030	EE302063	Tube, Aluminum Centering		EA 
119093	EE302081	Washer, Modified Steel for 5200 Bearing		EA 
119093D	EE302080	Washer, Steel for 4200 Bearing	VE01 VE01A	EA 
119094	EE302100	Washer, Rubber	VE01 VE01A VE08 VE08A	EA 
(119098A)	EE302120	Washer, Seal (Spacer)	VE01 VE01A	EA 
119126	EE302140	Washer, Spindle Plastic	VE02	EA 
119127A	EE302160	Washer, Steel Spindle	VE02	EA 
119152	EE302180	Pad, Foam, Unlined, 237mm OD X 68mm ID X 40mm Thick, White, (9 1/3" X 2 17/25" X 1 9/16")	VE07	EA 







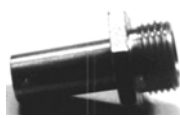

<b>OEM Part #</b>	<b>Epic No.</b>	<b>Description</b>	<b>Page</b>	
119203	EE302200	Washer, Small Rubber for 400 Base Shell	VE07	EA
				
119261B00	EE302244	Pad, Foam, Unlined, 270mm OD X 115mm ID X 30mm Thick, White (10 5/8" X 4 1/2" X 1 3/16")	VE14 VE15 VE28A	EA
				
119295B00	EE380146-1	Plate, Magnet, 48mm I.D., with Two Magnets for Verdol 400 Pot Base, R to RM Conversion and ICBT	VE07	EA
				
119313A	EE302220	Pad, Foam, Unlined, 292mm OD X 9.5mm ID X 19mm Thick, White, (11 1/2" X 3/8" X 3/4")	VE14	EA
				
119313A	EE302242	Pad, Foam, Unlined, 280mm OD X 57mm ID X 25mm Thick, White (11" X 2 1/4" X 1")	VE14 VE15	EA
				
(119313A)	EE302230	Pad, Foam, Unlined, 292mm OD X 9.5mm ID X 25mm Thick, White (11 1/2" X 3/8" X 1")	VE14	EA
				
(119313A)	EE302240	Pad, Foam, Unlined, 292mm OD X 89mm ID, 25mm Thick, White (11" X 3 1/2" X 1")	VE14 VE15	EA
				
(119313A)	EE302241	Pad, Foam, Unlined, 280mm OD X 76mm ID X 25mm Thick, White (11" X 3" X 1")	VE14	EA
				
(119313A)	EE302260	Pad, Foam, Unlined, 318mm OD X 9.5mm ID x 38mm Thick, White (12 1/2" X 3/8" X 1 1/2")	VE14	EA
				





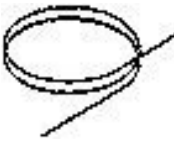



<b>OEM Part #</b>	<b>Epic No.</b>	<b>Description</b>	<b>Page</b>	
(119313A)	EE302262	Pad, Foam, Unlined, 318mm OD X 9.5mm ID X 51mm Thick, White (12 1/2" X 3/8" X 2")	VE14	EA 
(119313A)	EE302263	Pad, Foam, Unlined, 356mm OD X 19mm ID X 19mm Thick, White (14" X 3/4" X 3/4")	VE14	EA 
(119313A)	EE302270	Pad, Foam, Unlined, 381mm OD X 89mm ID X 51mm Thick, White (15" X 3 1/2" X 2")	VE14	EA 
(119355)	EE304710	Creel Support Disc, E&C Fiber	VE14 VE15	EA 
(119355)	EE304710-2	Disc, Creel, White Plastic, 1/4" Thick X 11" O.D. X 25/64 I.D.	VE14 VE15	EA 
119395C00	EE380146	Plate, Magnet, 52mm ID with two Magnets for Verdol 450 (Not Shown)	VE07	EA 
119460A00	EE380230	Guide Disc for Pot, 73mm	VE28	EA 
120002H	EE302280	Screw, Hardened Cam	VE01 VE01A VE02 VE02A VE18 VE19	EA 
(121442)	EE480437V	Tool, UniTensor, for Electric Drill	VE08	EA 











<b>OEM Part #</b>	<b>Epic No.</b>	<b>Description</b>	<b>Page</b>	
123007A	EE380164	Wire Keeper for RM, F44 & ICBT N Spindle	VE18 VE19 VE20 VE27	EA 
130001	EE302300	Nut, Large	VE01 VE01A	EA 
130002	EE302320	Nut, Small	VE01 VE01A	EA 
130010C	EE302340	Nut, Stabilizer	VE01 VE01A	EA 
130056B	EE380050	Nut, Aluminum Fastening, for Cabler Cap Tension Device	VE08 VE08A	EA 
130066A01	EE303436	Lock Nut, for 450 Base Shell		EA 
140001B	EE302360	Lock Washer, Large	VE01 VE01A	EA 
140002B	EE302380	Lock Washer, Small	VE01 VE01A	EA 
140003C	EE302400	Plate, Stabilizer Locking	VE01 VE01A	EA 

<b>OEM Part #</b>	<b>Epic No.</b>	<b>Description</b>	<b>Image</b>	<b>Page</b>	
151053G	EE302420	Clutch Cone, U Assembly		VE02	EA
(151053G)	EE302422	Pad, Woven Clutch for U/G Cone Assembly		VE02	EA
151055F	EE302440	Housing, U Whorl		VE02	EA
151120B	EE302460	Eyelet, Cylinder		VE01	EA
151138A	EE302480	Cover, Dust		VE01 VE01A	EA
151150	EE309056	Eyelet, Ceramic Tube, Tan		VE27	EA
151255G	EE302680	Extension, Base Shell, for 400, 450, 500 & 600		VE07 VE26	EA
(151274)	EE304900	Housing, Spindle, Converted U to R or G to R (Epic property)		VE01	EA
(151274)	EE305556	Housing, Spindle, Converted U to R or G to R, Exchange (CONTACT EPIC FOR PRICING)		VE01	EA

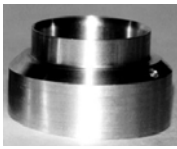
<b>OEM Part #</b>	<b>Epic No.</b>	<b>Description</b>	<b>Image</b>	<b>Page</b>	
(151274K)	EE302953	Plug, Plastic Spindle Housing, for converted U & G Housings		VE02A	EA
151380D	EE302500	Stabilizer, Assembly Complete		VE01 VE01A	EA
151389G	EE302520	Cylinder, R, U & G with Roll Pin & Set Screw		VE01 VE01A	EA
151390G	EE302522	Plug, Nylon Cylinder, Standard		VE01 VE01A	EA
151408A	EE402123V	Threader, Clear Nylon, 1.5mm X 900mm, Barbed			EA
151433	EE302540	Cover, Spindle Dust		VE01 VE01A VE06	EA
151435	EE302545	Ring, Spindle Dust		VE01 VE01A VE06	EA
(151522H)	EE304920	Spindle, Rebuild Customer Assembly G to R CONTACT EPIC FOR PRICING		VE01 VE02A VE04	EA
151651	EE302900	Cap Extension, for G Spindle		VE02	EA

<b>OEM Part #</b>	<b>Epic No.</b>	<b>Description</b>	<b>Page</b>	
151729B00	EE302600	Housing, Top Bearing	VE01 VE01A	EA 
151731S	EE302660	Bearing, Top Assembly, (Steel Cage)	VE01	EA 
151780	EE302680	Extension, Base Shell, for 400, 450, 500 & 600	VE07 VE26	EA 
151788A01	EE302720	Wire Handle Assembly	VE01 VE01A VE02 VE18 VE19	EA 
(151791)	EE302953	Plug, Plastic Spindle Housing, for converted U & G Housings	VE02A	EA 
(151791)	EE304900	Housing, Spindle,Converted U to R or G to R (Epic property)	VE01	EA 
(151791)	EE305556	Housing, Spindle, Converted U to R or G to R, Exchange (CONTACT EPIC FOR PRICING)	VE01	EA 
(151803)	EE304940	Spindle, Rebuild Customer Assembly U to R CONTACT EPIC FOR PRICING	VE01 VE02A VE04	EA 
(151803A)	EE305507-1	Spindle, Convert Customer U to EpiMag SA-III (RM Axle with Hardened Splines)		EA 









<b>OEM Part #</b>	<b>Epic No.</b>	<b>Description</b>		<b>Page</b>	
151806A	EE302760	Collar, U Thrust, Brass, with Pins		VE02	EA
(151822)	EE309054	Post, Ceramic, Tan, 5X17			EA
151830	EE302780	Plug, Nylon Cylinder O-Ring Type		VE01 VE01A	EA
151896	EE302800	Housing, Lower Oblique Bearing		VE01 VE01A	EA
151897	EE302820	Housing, Upper Oblique Bearing		VE01 VE01A	EA
151899	EE302840	Bearing, Lower Oblique Assembly		VE01	EA
151900	EE302860	Bearing, Upper Oblique Assembly		VE01	EA
151907A01	EE302880	Tube, Centering		VE01	EA
151918	EE302900	Cap Extension, for G Spindle		VE02	EA









EE is an Epic trademark designating Epic parts

Verdol is a trademark of Rieter/ ICBT

© Epic Enterprises, April 2009

Epic products are intended as replacements for worn or damaged parts in OEM products. OEM Part numbers in (parenthesis) indicate either 1) Improved design 2) the part serves the same function as the OEM part, but may differ from the OEM design, or 3) it is a component of an assembly where no OEM reference number is available, or 4) it is a repair service for the referenced OEM part.

<b>OEM Part #</b>	<b>Epic No.</b>	<b>Description</b>	<b>Page</b>	
151919	EE302920	Cap Extension for U Spindle	VE02	EA
				
151928A01	EE302923	Guard, Yarn (Large), for 200mm Reserve Disc	VE06	EA
				
151931A	EE302924	Guard, Yarn (Small), for 160mm Reserve Disc	VE06	EA
				
(151964)	EE305500-3	Spindle, New, for EpiMag SA-II (R Axle with Hardened Splines)		EA
				
151964A01	EE304840	Spindle Assembly, R	VE01	EA
				
(151964A01)	EE304840-1	Spindle Assembly, R, Complete, Rebuilt for Exchange CONTACT EPIC FOR PRICING	VE04	EA
				
151964R	EE302930	Spindle, Rebuild Customer R CONTACT EPIC FOR PRICING	VE01 VE04	EA
				
(151965A)	EE302940	Axle, R Spindle	VE01 VE01A VE02A	EA
				
(151965A)	EE302940-1	Axle, R Spindle, Hardened Spline	VE01A VE02A	EA
				

<b>OEM Part #</b>	<b>Epic No.</b>	<b>Description</b>	<b>Page</b>	
(151965A)	EE302940-2	Axle, R Spindle for Cabling	VE01A VE02A	EA
				
(151965A)	EE302940-3	Axle, R Spindle for Cabling with Hardened Spline	VE01A VE02A	EA
				
(151965A)	EE302944	Checker, Axle, with Dial Indicator		EA
				
(151965A)	EE302946	Checker, Axle without Dial Indicator		EA
				
(151965A)	EE302952	Plug, Rubber		EA
				
(151966A)	EE303114	Repair, Cam Screw Thread		EA
				
(151966A)	EE303114-1	Repair, Heli-Coil of Base Screw Holes on R Spindle Housing		EA
				
(151966A)	EE304900	Housing, Spindle, Converted U to R or G to R (Epic property)	VE01	EA
				
(151966A)	EE305556	Housing, Spindle, Converted U to R or G to R, Exchange (CONTACT EPIC FOR PRICING)	VE01	EA
				

<b>OEM Part #</b>	<b>Epic No.</b>	<b>Description</b>		<b>Page</b>	
151966A03	EE340036-1	Housing, R and RM Spindle with Dust Ring		VE01 VE02A VE18	EA
(151966A03)	EE340036	Housing, R and RM Spindle		VE01 VE02A VE18	EA
(151970D)	EE302980-1	Clutch Cone Assembly, STEEL, R or RM, Hardened		VE01 VE01A	EA
151972A	EE303000	Housing, R or RM Whorl,40mm		VE01 VE01A VE18	EA
151972B01	EE380108	Whorl, for F44 Spindle		VE19	EA
151973A	EE303020	Washer, Steel, for R, RM & F44 Spindle		VE01 VE01A VE18 VE19	EA
151974A03	EE303040	Spacer, Spring		VE01 VE01A VE18 VE19	EA
151975	EE303060	Sleeve, R Cam (Hardened) (Does Not Require Wear Pad)		VE01 VE01A VE18 VE19	EA
151975A	EE303082	Sleeve, R Cam (Hardened) With Wear Pad		VE01 VE01A VE18 VE19	EA

EE is an Epic trademark designating Epic parts

Verdol is a trademark of Rieter/ ICBT

© Epic Enterprises, April 2009

Epic products are intended as replacements for worn or damaged parts in OEM products. OEM Part numbers in (parenthesis) indicate either 1) Improved design 2) the part serves the same function as the OEM part, but may differ from the OEM design, or 3) it is a component of an assembly where no OEM reference number is available, or 4) it is a repair service for the referenced OEM part.



<b>OEM Part #</b>	<b>Epic No.</b>	<b>Description</b>	<b>Page</b>	
151975B	EE303060	Sleeve, R Cam (Hardened) (Does Not Require Wear Pad)	VE01 VE01A VE18 VE19	EA
151975B	EE303080	Sleeve, R Cam (Hardened) with Hardened Cam Screws	VE01 VE01A VE18 VE19	EA
151975B00	EE303060	Sleeve, R Cam (Hardened) (Does Not Require Wear Pad)	VE01 VE01A VE18 VE19	EA
151975C	EE303084	Sleeve, R Cam (Hardened) with Wear Pad and Hardened Screws	VE01A VE18 VE19	EA
151976A01	EE303180	Cap, Bottom Housing, with O-Ring & Grease Fitting	VE01 VE01A VE18 VE19	EA
151977A	EE303101	Whorl Assembly, R or RM (NTN)	VE01	EA
151980A00	EE309096	Axle, R, and Cylinder Assembly	VE01	EA
(151981)	EE302958	Polish, Customer Spindle Housing - the Base Only		EA
(151981)	EE303110	Conversion, Customer Spindle Housing from U to R with .100 sleeve		EA

<b>OEM Part #</b>	<b>Epic No.</b>	<b>Description</b>		<b>Page</b>
(151981)	EE303110-1	Conversion, Customer Spindle Housing from U to R with .150" Sleeve		EA
(151981)	EE303111	Sleeve, Relocate Conversion		EA
151981A00	EE340036-1	Housing, R and RM Spindle with Dust Ring		VE01 VE02A VE18 EA
(151981A00)	EE303114-1	Repair, Heli-Coil of Base Screw Holes on R Spindle Housing		EA
(151981A00)	EE340036	Housing, R and RM Spindle		VE01 VE02A VE18 EA
(151981BUS)	EE303112	Sleeve Lower Spindle Housing (with steel sleeve from Epic)		EA
152030C	EE380141	Magnet, for Verdol F44, RM and ICBT		VE18 VE19 VE20 VE28 VE28A EA
(152044A01)	EE309057	Cost to Replace Customer Hub in RM or N Disc & Balance		VE18 EA
152045A00	EE303120	Spacer, for R and RM Spindles		VE01 VE01A VE18 EA

EE is an Epic trademark designating Epic parts

Verdol is a trademark of Rieter/ ICBT

© Epic Enterprises, April 2009

Epic products are intended as replacements for worn or damaged parts in OEM products. OEM Part numbers in (parenthesis) indicate either 1) Improved design 2) the part serves the same function as the OEM part, but may differ from the OEM design, or 3) it is a component of an assembly where no OEM reference number is available, or 4) it is a repair service for the referenced OEM part.

<i>OEM Part #</i>	<i>Epic No.</i>	<i>Description</i>	<i>Page</i>
152053B	EE303140-4	Clutch Cone Assembly, BRONZE, SA	VE01 VE01A VE18 VE19
152074A	EE303160	Cover, Dust, Plastic	VE01 VE01A VE18 VE19
(152082A00)	EE303064	Pad, Wear for EE303082 or EE303084	VE01A VE18 VE19
(152084A00)	EE303115	Sleeve, Repair, for Lower Spindle Housing	VE01
(152084A00)	EE303116	Sleeve, Repair, Lower Spindle Housing (Larger OD)	VE01
152087A01	EE303180	Cap, Bottom Housing, with O-Ring & Grease Fitting	VE01 VE01A VE18 VE19
(152088A00)	EE303200	Sleeve, Standard .100" Flanged, for Rebores Housing with O-Ring	VE01 VE02A
(152088A00)	EE303200-1	Sleeve, for Relocation, .150" Flanged, for Rebores Housing with O-Ring	VE01 VE02A
(152088A00)	EE303200-2	Sleeve for Damaged Housing, 0.150", Flanged, for Rebores Housing with O-Ring	VE01 VE02A

EE is an Epic trademark designating Epic parts

Verdol is a trademark of Rieter/ ICBT

© Epic Enterprises, April 2009

Epic products are intended as replacements for worn or damaged parts in OEM products. OEM Part numbers in (parenthesis) indicate either 1) Improved design 2) the part serves the same function as the OEM part, but may differ from the OEM design, or 3) it is a component of an assembly where no OEM reference number is available, or 4) it is a repair service for the referenced OEM part.

<b>OEM Part #</b>	<b>Epic No.</b>	<b>Description</b>	<b>Page</b>	
(152096A)	EE304920	Spindle, Rebuild Customer Assembly G to R CONTACT EPIC FOR PRICING	VE01 VE02A VE04	EA 
(152096A)	EE304940	Spindle, Rebuild Customer Assembly U to R CONTACT EPIC FOR PRICING	VE01 VE02A VE04	EA 
(152144)	EE309034	Cost to Balance RM & N Rotor Assembly		EA 
152152A	EE340036-1	Housing, R and RM Spindle with Dust Ring	VE01 VE02A VE18	EA 
152153A00	EE303210	Axle, N Spindle (Old Version), 450	VE27	EA 
152154A	EE380106	Hub for N Spindle, 450	VE27	EA 
152155A00	EE380197	Housing, Lower, for "N" Spindle	VE27	EA 
152156B01	EE380208	Bearing Housing, Upper, Old Style "N" Verdol (Not ICBT)	VE27	EA 
152158A01	EE380148	Plate, Lower Magnet, with Magnets for Verdol RM, F44 Spindle	VE18 VE19 VE27	EA 

EE is an Epic trademark designating Epic parts

Verdol is a trademark of Rieter/ ICBT

© Epic Enterprises, April 2009

Epic products are intended as replacements for worn or damaged parts in OEM products. OEM Part numbers in (parenthesis) indicate either 1) Improved design 2) the part serves the same function as the OEM part, but may differ from the OEM design, or 3) it is a component of an assembly where no OEM reference number is available, or 4) it is a repair service for the referenced OEM part.

<b>OEM Part #</b>	<b>Epic No.</b>	<b>Description</b>	<b>Page</b>	
152158B01	EE380148	Plate, Lower Magnet, with Magnets for Verdol RM, F44 Spindle	VE18 VE19 VE27	EA 
152160A01	EE380144	Plate, Upper Magnet, with Magnets for Verdol Spindles, RM, F44, & ICBT	VE18 VE19 VE20	EA 
152160B00	EE380144	Plate, Upper Magnet, with Magnets for Verdol Spindles, RM, F44, & ICBT	VE18 VE19 VE20	EA 
152160C00	EE380144	Plate, Upper Magnet, with Magnets for Verdol Spindles, RM, F44, & ICBT	VE18 VE19 VE20	EA 
(152160C00)	EE380144-1	Plate, Upper Magnet, with Magnet & Grommet for Verdol Spindles, RM, F44, & ICBT	VE18 VE19 VE20 VE27	EA 
152174A00	EE309040	Eyelet, Ceramic,for Reserve Disc	VE18 VE19 VE20	EA 
(152183)	EE309034	Cost to Balance RM & N Rotor Assembly		EA 
152272B	EE303216	Deflector, Large, for RM, Original Type, 175mm Reserve Discs	VE18 VE19	EA 
152272C	EE303217	Deflector, Small, for RM, Original Type, 160mm Reserve Discs	VE18	EA 

EE is an Epic trademark designating Epic parts

Verdol is a trademark of Rieter/ ICBT

© Epic Enterprises, April 2009

Epic products are intended as replacements for worn or damaged parts in OEM products. OEM Part numbers in (parenthesis) indicate either 1) Improved design 2) the part serves the same function as the OEM part, but may differ from the OEM design, or 3) it is a component of an assembly where no OEM reference number is available, or 4) it is a repair service for the referenced OEM part.

<b>OEM Part #</b>	<b>Epic No.</b>	<b>Description</b>	<b>Page</b>	
(152276A00)	EE303220	Axle, RM Spindle	VE18	EA
(152276A00)	EE303220-1	Axle, RM Spindle (With Hardened Splines)	VE18	EA
(152276A00)	EE303220-2	Axle, Spindle, RM with Hardened Splines for EpiMag SAIII	VE05A	EA
(152276A00)	EE303220-4	Axle, Spindle, RM,with Hardened Splines for Cabling, for EpiMag SAIII	VE05A	EA
(152276A01)	EE303220	Axle, RM Spindle	VE18	EA
(152276A01)	EE303220-1	Axle, RM Spindle (With Hardened Splines)	VE18	EA
(152276A01)	EE303220-2	Axle, Spindle, RM with Hardened Splines for EpiMag SAIII	VE05A	EA
(152276A01)	EE303220-4	Axle, Spindle, RM,with Hardened Splines for Cabling, for EpiMag SAIII	VE05A	EA
(152276C)	EE303220	Axle, RM Spindle	VE18	EA

EE is an Epic trademark designating Epic parts

Verdol is a trademark of Rieter/ ICBT

© Epic Enterprises, April 2009

Epic products are intended as replacements for worn or damaged parts in OEM products. OEM Part numbers in (parenthesis) indicate either 1) Improved design 2) the part serves the same function as the OEM part, but may differ from the OEM design, or 3) it is a component of an assembly where no OEM reference number is available, or 4) it is a repair service for the referenced OEM part.









<b>OEM Part #</b>	<b>Epic No.</b>	<b>Description</b>	<b>Page</b>	
(152276C00)	EE303221	Axle, F44 Spindle (With Hardened Spline)	VE19	EA 
(152278A00)	EE380167	Hub, Aluminum, for RM & F44 Spindle	VE18 VE19	EA 
152279A00	EE380165	Bearing Housing, Upper, for RM & F44 Spindle	VE18 VE19	EA 
(152280)	EE309034	Cost to Balance RM & N Rotor Assembly		EA 
(152280A00)	EE309057	Cost to Replace Customer Hub in RM or N Disc & Balance	VE18	EA
(152280AR)	EE304842	Spindle, Rebuild Customer RM Assembly Complete CONTACT EPIC FOR PRICING	VE01 VE04 VE18	EA 
(152280AR)	EE304842-1	Spindle Assembly, RM, Complete, Rebuilt for Exchange CONTACT EPIC FOR PRICING	VE01 VE04 VE18	EA 
152282A00	EE305546	RM Spindle, New, Complete with 260 X 175 Disc Assembly	VE18	EA 
152318A	EE303230	Axle, N Spindle (New Version), 450		EA 

EE is an Epic trademark designating Epic parts









Verdol is a trademark of Rieter/ ICBT

© Epic Enterprises, April 2009

Epic products are intended as replacements for worn or damaged parts in OEM products. OEM Part numbers in (parenthesis) indicate either 1) Improved design 2) the part serves the same function as the OEM part, but may differ from the OEM design, or 3) it is a component of an assembly where no OEM reference number is available, or 4) it is a repair service for the referenced OEM part.

<b>OEM Part #</b>	<b>Epic No.</b>	<b>Description</b>	<b>Page</b>	
(152385A02)	EE380219	Sleeve for F44 Spindle Housing, New Style (Use with VE19-06A and VE19-06C)	VE19	EA
				
(152389)	EE305506-1	Spindle, Convert Customer R to EpiMag SA-III (RM Axle with Hardened Splines) CONTACT EPIC FOR PRICING	VE05	EA
				
(152389)	EE305508	Spindle, EpiMag SA-III (RM Axle with Hardened Splines)	VE05	EA
				
(152389)	EE305509-2	Spindle, Convert Customer G to EpiMag SA-III (RM Axle with Hardened Splines)		EA
				
(152389A01)	EE304842	Spindle, Rebuild Customer RM Assembly Complete CONTACT EPIC FOR PRICING	VE01 VE04 VE18	EA
				
(152389A01)	EE304842-1	Spindle Assembly, RM, Complete, Rebuilt for Exchange CONTACT EPIC FOR PRICING	VE01 VE04 VE18	EA
				
(153114)	EE480437V	Tool, UniTensor, for Electric Drill	VE08	EA
				
160801	EE303614	Balloon Centering Guide Complete with Pigtail, 450	VE09	EA
				
(170209)	EE480437V	Tool, UniTensor, for Electric Drill	VE08	EA
				



<b>OEM Part #</b>	<b>Epic No.</b>	<b>Description</b>	<b>Page</b>	
200316A	EE303240	Holder, Creel Hardwood Tube, 3/8" Diameter Bore	VE14	EA 
200316B	EE303240-1	Holder, Creel Hardwood Tube, 5/8" Diameter Bore	VE14	EA 
200316C	EE303240-2	Holder, Creel Hardwood Tube, 3/4" Diameter Bore	VE14	EA 
200316D	EE303240-3	Holder, Creel Hardwood Tube, 13/16" Diameter Bore with 5/16" Allen Head Cup Point Set Screw	VE14	EA 
201077A	EE340045	Disc and Reserve Assembly, Stainless, 260 X 175mm, RM, F44 & ICBT	VE18 VE19 VE20	EA 
201077B	EE340045	Disc and Reserve Assembly, Stainless, 260 X 175mm, RM, F44 & ICBT	VE18 VE19 VE20	EA 
(201078)	EE309043	Screw for Balancing		EA 
(201078F)	EE340011	Repair of Threading Channel 160 & 175mm, and Balance	VE18 VE19 VE20	EA 
(201078F)	EE340044	Repair, ICBT or Verdol RM/F44 Spindle Disc Assembly, 260X160, with New Mounting Hub (EE340022) and Balance	VE18 VE19 VE20	EA 

EE is an Epic trademark designating Epic parts

Verdol is a trademark of Rieter/ ICBT

© Epic Enterprises, April 2009

Epic products are intended as replacements for worn or damaged parts in OEM products. OEM Part numbers in (parenthesis) indicate either 1) Improved design 2) the part serves the same function as the OEM part, but may differ from the OEM design, or 3) it is a component of an assembly where no OEM reference number is available, or 4) it is a repair service for the referenced OEM part.

<b>OEM Part #</b>	<b>Epic No.</b>	<b>Description</b>	<b>Page</b>	
201100A02	EE340066	Disc and Reserve Assembly, Stainless, 280 X 200, Low Profile, ICBT CD/DT, Verdol 400/500/600	VE18 VE19 VE20	EA 
(201100B00)	EE309123	Repair Threading Channel with 10mm Stainless Steel Tube and Rebalance; 280 X 200mm Disc Assembly, ICBT N and Verdol RM & F44	VE18 VE19 VE20	EA 
201119B	EE340021	Disc and Reserve Assembly, Stainless, 260 X 160mm for RM, F44 and ICBT	VE18 VE19 VE20	EA 
201119C	EE340021	Disc and Reserve Assembly, Stainless, 260 X 160mm for RM, F44 and ICBT	VE18 VE19 VE20	EA 
(201155B)	EE303216-2	Deflector with Hub, 175mm, for New Type F44 Spindle	VE19	EA
(201155B)	EE303217	Deflector, Small, for RM, Original Type, 160mm Reserve Discs	VE18	EA 
(201155C)	EE303216	Deflector, Large, for RM, Original Type, 175mm Reserve Discs	VE18 VE19	EA 
(201155C)	EE303217-1	Deflector with Hub, 160mm, for New Type F44 Spindle	VE19	EA
(202014A00)	EE303260-1	Pot, Stainless, 290H240, for 235mm Disc, with Double Lock (See EE340000 for repair)	VE07	EA 

<b>OEM Part #</b>	<b>Epic No.</b>	<b>Description</b>	<b>Image</b>	<b>Page</b>	
(202014A00)	EE340000	Pot, Stainless, 290H240, for 235mm Disc, Repaired with Double Lock		VE07	EA
(202014A00)	EE340065	Pot, Stainless (290H240) Repaired with Double Lock, Exchange		VE07	EA
(202068B00)	EE309138	Pot, Stainless, Complete, 290H240, 500 Gauge, for 260mm Disc, Repaired with Double Lock		VE07	EA
(202068B00)	EE340010	Pot, Stainless, 290H240, 500 Gauge, for 260mm Disc, Repaired with Double Lock		VE07	EA
(202068B00)	EE340071	Pot, Stainless, 290H240, 500 Gauge, for 260mm Disc with Double Lock		VE07	EA
202111A01	EE303300	Pot, Stainless, 450, 290H310N		VE07	EA
202111A01	EE303320	Pot, Stainless Reduction, 450, Repair, (290H310N)		VE07	EA
(202126A01)	EE303340-1	Pot, Stainless, 290H300, with Double Lock		VE07	EA
(202126A01)	EE303360-1	Pot, Stainless, with Double Lock, Repair of 400 290H300		VE07	EA

EE is an Epic trademark designating Epic parts

Verdol is a trademark of Rieter/ ICBT

© Epic Enterprises, April 2009

Epic products are intended as replacements for worn or damaged parts in OEM products. OEM Part numbers in (parenthesis) indicate either 1) Improved design 2) the part serves the same function as the OEM part, but may differ from the OEM design, or 3) it is a component of an assembly where no OEM reference number is available, or 4) it is a repair service for the referenced OEM part.

<i>OEM Part #</i>	<i>Epic No.</i>	<i>Description</i>	<i>Page</i>	
202162B01	EE380017	Device, Balloon Deflection	VE07 VE28 VE28A	EA
				
20283101	EE303760-1	Screw, Socket Head Cap, 5X25	VE20	EA
				
20283401	EE303760	Screw, Socket Head Cap, 5X16	VE01 VE01A VE02 VE18 VE19	EA
				
20283501	EE330358	Screw, Socket Head Cap, 5X25, Zinc Plated	VE27	EA
				
(20283501)	EE303760-1	Screw, Socket Head Cap, 5X25	VE20	EA
				
202845A01	EE340024	Pot Lid, Stainless Steel, for 290mm Pot	VE08 VE08A VE28 VE28A	EA
				
20285101	EE430227V	Screw, Socket Head Cap 6X30	VE10	EA
				
20285201	EE430228V	Screw, Socket Head Cap 6X35		EA
				
20325701	EE331234	Screw, Hex Socket Flat Point Set, 10X25	VE20	EA
				









<b>OEM Part #</b>	<b>Epic No.</b>	<b>Description</b>	<b>Page</b>	
2034301	EE303780	Screw, Hex Socket Cone Point Set, 6X12	VE01 VE18 VE19	EA 
204227	EE303370	Balloon Centering Guide Pigtail Assembly	VE09	EA 
205000A	EE303380	Guide, Small Ceramic Yarn Traverse	VE03	EA 
205202B03	EE380159	Eyelet, Entry, RM & F44	VE18 VE19	EA 
(205206)	EE309056	Eyelet, Ceramic Tube, Tan	VE27	EA 
205212B00	EE309056	Eyelet, Ceramic Tube, Tan	VE27	EA 
205218G00	EE309040	Eyelet, Ceramic, for Reserve Disc	VE18 VE19 VE20	EA 
205228F00	EE380172	Eyelet, Ceramic, for ICBT N Spindle	VE20 VE27	EA 
205229F00	EE380173	Guide, Two Way, Channel for ICBT N Spindle	VE20 VE27	EA 



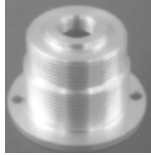
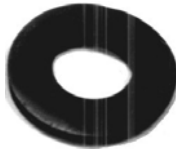





EE is an Epic trademark designating Epic parts

Verdol is a trademark of Rieter/ ICBT

© Epic Enterprises, April 2009







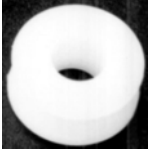

Epic products are intended as replacements for worn or damaged parts in OEM products. OEM Part numbers in (parenthesis) indicate either 1) Improved design 2) the part serves the same function as the OEM part, but may differ from the OEM design, or 3) it is a component of an assembly where no OEM reference number is available, or 4) it is a repair service for the referenced OEM part.

<b>OEM Part #</b>	<b>Epic No.</b>	<b>Description</b>	<b>Image</b>	<b>Page</b>	
206033A	EE303400	Base Shell Assembly, Aluminum, for 400, 500, 600		VE07	EA
206041A0	EE303420	Base Shell, Aluminum, for Model 400, 500, 600		VE07	EA
(206071)	EE303431	Base Shell Only, Aluminum, for Model 450		VE07	EA
(206071)	EE303432	Washer, Small Urethane, for 450 Base Shell		VE07	EA
(206071)	EE303433	Washer, Large Rubber, for 450 Base Shell		VE07	EA
(206071)	EE303434	O-Ring, Large, Internal, for 450 Base Shell		VE07 VE28 VE28A	EA
(206071)	EE303435	O-Ring, Small, Internal, for 450 Base Shell and ICBT Base Shell		VE07	EA
206071B02	EE303430	Base Shell Assembly, Aluminum, for 450		VE07	EA
206080AOO	EE380226	Base Shell Assembly for Pot, RM & F44			EA

<b>OEM Part #</b>	<b>Epic No.</b>	<b>Description</b>	<b>Page</b>	
(206080A00)	EE380227	Base Shell Only for Pot, RM & F44		EA
				
206728	EE380023-1	Tube, Wood Centering for Pot, with Set Screw	VE07	EA
				
206810	EE303440	Pad, Felt, Unlined, 290mm OD X 68mm ID X 7mm Thick, Gray (11 2/5" X 2 17/25" X 7/25")	VE07	EA
				
(207329)	EE440095-2	UniTensor™, Verdol Mount, Chrome Discs	VE08	EA
				
(207329)	EE440095-3	UniTensor™, Verdol Mount, Ceramic Discs	VE08	EA
				
(207329)	EE440095-5	UniTensor™, Verdol Mount, Chrome Discs, Extended Bottom Eye	VE08	EA
				
(207329A01)	EE309048	Tension Device, Standard Cabler Cap, for Verdol with Chrome Discs (Aluminum Bracket)	VE08A	EA
				
(207329A01)	EE309048-1	Tension Device, Standard Cabler Cap, for Verdol with Ceramic Discs (Aluminum Bracket)	VE08A	EA
				
(207330)	EE480425-1	Bracket, Main, with Guide Bushing for UniTensor (3-Post)	VE08	EA
				

<b>OEM Part #</b>	<b>Epic No.</b>	<b>Description</b>	<b>Page</b>	
207366B00	EE309072	Capsule, Tension #1 for Verdol	VE07	EA
				
(208053)	A-18326	Adaptor, Safety Take-Up (replaces 208053)	VE12 VE28 VE28A	EA
				
(208053)	EE380155	Adaptor, Take-Up Tube, Plastic (Replaces Verdol 208053)	VE12	EA
				
(210524A)	EE303462-3	Cot, Red/Brown, 124X275X2.2mm, for 400, 500 & 600 Take-Up Roll	VE24	EA
				
210524R	EE303462-3	Cot, Red/Brown, 124X275X2.2mm, for 400, 500 & 600 Take-Up Roll	VE24	EA
				
211343BOO	EE340041	Mounting Bracket, Steel, for Verdol Spindle		EA
				
211363	EE303470	Tubing, Traverse, 10X1598mm	VE03	EA
				
(211386)	EE305050	Ring, Balloon Control, Repaired (1 Bracket)	VE07	EA
				
(211386)	EE305051	Ring, Balloon Control, Repaired (2 Brackets)	VE07	EA
				



<b>OEM Part #</b>	<b>Epic No.</b>	<b>Description</b>	<b>Page</b>	
211430	EE303470	Tubing, Traverse, 10X1598mm	VE03	EA
				
212113B	EE303472	Roller, Traverse, Verdol Type	VE03	EA
				
212214	EE434228V	Ring, External Retaining, 42X1.75	VE18 VE19 VE20 VE27	EA
				
212407	EE304640	Ring, External Retaining (12E or C1.012)	VE02 VE20	EA
				
212408	EE304040	Ring, External Retaining, 16mm (16E or C1.016)	VE01 VE01A VE02 VE18 VE19	EA
				
212605	EE434404V	Circlip, External, 6mm		EA
				
212664	EE304448	Washer, Spacer, for RM, F44 & ICBT N Spindle	VE18 VE19 VE20 VE27	EA
				
212670	EE304060	Ring, Cylinder Retaining (I 16K)	VE01 VE01A	EA
				
212671	EE303880	Ring, External Retaining, (10E or C1.010)	VE01 VE01A VE18 VE19	EA
				







EE is an Epic trademark designating Epic parts





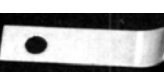

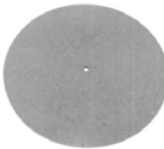
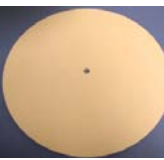

Verdol is a trademark of Rieter/ ICBT







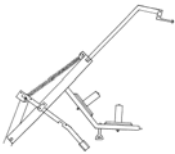

© Epic Enterprises, April 2009

Epic products are intended as replacements for worn or damaged parts in OEM products. OEM Part numbers in (parenthesis) indicate either 1) Improved design 2) the part serves the same function as the OEM part, but may differ from the OEM design, or 3) it is a component of an assembly where no OEM reference number is available, or 4) it is a repair service for the referenced OEM part.

<b>OEM Part #</b>	<b>Epic No.</b>	<b>Description</b>	<b>Page</b>	
212690A	EE380155	Adaptor, Take-Up Tube, Plastic (Replaces Verdol 208053)	VE12	EA 
213245	EE303615	Balloon Centering Guide with Spacer and Pigtail	VE09	EA 
(213245)	EE304682	Spacer for Long Guide Holder Stud EE303615	VE09	EA 
213401A	EE380078	Adaptor, Package Centering, with Set Screw (EE331218)	VE12	EA 
(213401A)	EE303672	Tube Centering Piece, Plastic	VE12	EA 
213538A03	EE305547-1	Friction Roll without Cot, Verdol 400 and 500	VE24	EA 
(214444)	EE305547-1	Friction Roll without Cot, Verdol 400 and 500	VE24	EA 
(214631)	EE380049	Stud, Brass Threaded for Cabler Cap Tension Device	VE08 VE08A	EA 
214650	EE380051	Arbor Assembly for Verdol Take-Up Assembly	VE12	EA 

<i>OEM Part #</i>	<i>Epic No.</i>	<i>Description</i>	<i>Page</i>	
215050A00	EE380156	Handle, Short, for Verdol Creel		EA
				
215356	EE309042	Rivet, Aluminum, 2.5 X 8mm	VE27	EA
				
215482	EE303502	Clip, Yarn, for Overfeed Cover	VE11 VE16	EA
				
215501	EE380181	Rail, Intermediate Mounting		EA
				
215793	EE303520	Plate, Bottom Channel	VE16	EA
				
(215808)	EE304710	Creel Support Disc, E&C Fiber	VE14 VE15	EA
				
(215808)	EE304710-2	Disc, Creel, White Plastic, 1/4" Thick X 11" O.D. X 25/64 I.D.	VE14 VE15	EA
				
(215812)	A-18051	T-Handle for E Creel	VE14	EA
				
(215814)	A-18283	Latch, 400 Safety Kit (E) (3/4" Shaft)	VE14	EA
				

<b>OEM Part #</b>	<b>Epic No.</b>	<b>Description</b>	<b>Page</b>	
(215814)	A-18283A	Latch, 400 Safety Kit (E) (20mm Shaft)	VE14	EA
				
(215814)	A-18284	Latch, 450 Safety Kit (E)	VE14	EA
				
(215951)	A-18055	Bracket, Pretension Mounting	VE14	EA
				
215958	EE303580	Stud, Tailing with Set Screw	VE10	EA
				
215977A00	EE303600	Flange, Take-Up Tube	VE12	EA
				
215991A00	EE303620	Down Tube Assembly with Brackets (Both Ends Closed)		EA
				
(215991A00)	EE303620A	Down Tube Assembly with Brackets (Top Channel Open)	VE16	EA
				
215992A01	EE303520	Plate, Bottom Channel	VE16	EA
				
(216049)	EE304720	Arm, Extension, E Creel (A-18054)	VE14	EA
				

<b>OEM Part #</b>	<b>Epic No.</b>	<b>Description</b>	<b>Page</b>	
(216049)	EE304800	Creel, E, Complete (A-18239) CONTACT EPIC FOR PRICING	VE14	EA 
(216128)	EE304700	Arm, E Creel (A-18049)	VE14	EA 
216316	EE303610	Stud, Short Guide Holder for EE303614	VE09	EA 
(216316)	EE303611	Stud, Long Guide Holder for EE303615	VE09	EA 
216318	EE303612	Plate, Centering Guide Fitting	VE09	EA 
(216901)	EE380020	Roller, V-Groove Assembly	VE16 VE22	EA 
(216901)	EE980042V	Ceramic Roller and Bracket with Replaceable Ball Bearing	VE16	EA 
216935	EE303640	Support, Bottom Roller, 400 Gauge	VE16	EA 
(216935)	EE303640-1	Support, Bottom Roller, 600 Gauge	VE16	EA 

<b>OEM Part #</b>	<b>Epic No.</b>	<b>Description</b>	<b>Page</b>	
217498J00	EE303470	Tubing, Traverse, 10X1598mm	VE03	EA
				
(217793)	EE340026	Creel, Epic Style Overhead, for Model 450 Verdol, 120 Position, Manual Safety Latch CONTACT EPIC FOR PRICING	VE14	EA
218047A	EE305548-1	Friction Roller, Grooved, Without Cot, for Verdol 450	VE24	EA
				
218147A	EE305548	Friction Roller Assembly, Verdol 450, with Narrow Cot	VE24	EA
				
218149A01	EE305545	Friction Roller Assembly, ICBT and Verdol 450 with Full Length Cot	VE24	EA
				
(218149A01)	EE305550	Install Epic Full Length Cot EE305542 on Customer's Cotless Roll, ICBT and Verdol 450 (Minimum 12 pieces)	VE24	EA
				
(218149A01)	EE309103	Strip Customer Verdol 450 or ICBT Friction Roll and install Full Length Cot EE305542 (Minimum 12 pieces)	VE24	EA
				
218151A01	EE305545-1	Friction Roller without Cot for ICBT and Verdol 450	VE24	EA
				
(218151A01)	EE305550	Install Epic Full Length Cot EE305542 on Customer's Cotless Roll, ICBT and Verdol 450 (Minimum 12 pieces)	VE24	EA
				





EE is an Epic trademark designating Epic parts

Verdol is a trademark of Rieter/ ICBT

© Epic Enterprises, April 2009

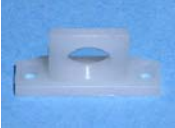







Epic products are intended as replacements for worn or damaged parts in OEM products. OEM Part numbers in (parenthesis) indicate either 1) Improved design 2) the part serves the same function as the OEM part, but may differ from the OEM design, or 3) it is a component of an assembly where no OEM reference number is available, or 4) it is a repair service for the referenced OEM part.







<b>OEM Part #</b>	<b>Epic No.</b>	<b>Description</b>	<b>Page</b>	
218154A01	EE305549	Cot, Gray, 89.5 X 138 X 2mm for Verdol 450 Friction Roll	VE24	EA 
218155A01	EE305542	Cot, Gray, Full Length, 89.5 X 276 X 2mm for Verdol 450 and ICBT Friction Rolls	VE24	EA 
218642A00	EE380022	Roller, V-Groove for Roller Assembly EE380020	VE22	EA 
218643F01	EE380021	Cap, End for Roller Assembly EE380020	VE22	EA 
218842A00	EE380020	Roller, V-Groove Assembly	VE16 VE22	EA 
(218895A00)	EE309139	Recoat Conveyor Drive Roll, Verdol 500		EA 
219111A01	EE303470-1	Tubing, Traverse, 10X1998mm	VE03	EA 
219811A00	EE380243	Roller, Guide, for ICBT Traverse Rod, Top, Large		EA 
219844A00	EE380242	Roller, Guide, for ICBT Traverse Rod, Bottom, Large		EA 

<b>OEM Part #</b>	<b>Epic No.</b>	<b>Description</b>	<b>Page</b>	
219944A00	EE380242	Roller, Guide, for ICBT Traverse Rod, Bottom, Large		EA
				
220240A00	EE380059	Eyelet Retaining Piece for Hub/Reserve	VE18 VE19 VE20	EA
				
221789A01	EE305547	Friction Roll with Cot, Verdol 400 and 500	VE24	EA
				
(221789A01)	EE309101	Strip Customer Verdol 400 Friction Roll and Install EE303462-3 Cot (Minimum Order: 12 Pieces)	VE24	EA
				
22294106	EE438000V	Screw, Slotted Pan Head Tapping, 2.9x9.5	VE19	EA
				
22295201	EE309041	Screw for Eyelet Holder	VE20	EA
				
22300301	EE333350	Nut, Hex, Zinc Plated, 6mm	VE22	EA
				
(22513001)	A-18356	Washer, Regular Flat 3/8", Plated	VE09 VE14 VE15 VE16 VE23	EA
				
22513401	EE431602V	Washer, Regular Flat, 8mm	VE09	EA
				

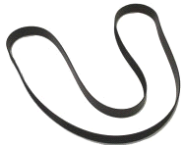
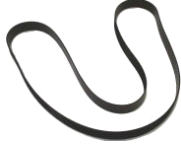

<b>OEM Part #</b>	<b>Epic No.</b>	<b>Description</b>		<b>Page</b>	
22520201	EE303860	Washer, External Serrated Lock, 5mm (Unplated)		VE01 VE01A VE02 VE10 VE18 VE19	EA
22534701	EE380166	Washer, Wave, for RM, F44 & ICBT N Spindle		VE18 VE19 VE20 VE27	EA
230119	EE340045	Disc and Reserve Assembly, Stainless, 260 X 175mm, RM, F44 & ICBT		VE18 VE19 VE20	EA
270123	EE301317V	Pre-Take-Up/Overfeed Assembly, 31 Flute Chrome "Volkman Type" with Locking Collar		VE11	EA
270145A00	EE303664	Pad, Brake, 20mm for N Spindle			EA
300308	EE309032	Bearing for Roller Assembly EE380020		VE22	EA
301331	EE309047	Bearing, F44 Housing (NTN)		VE19	EA
301634	EE304245	Bearing, Whorl, for F44, 63203		VE19	EA
301642	EE304300	Bearing, N Spindle, 450, 6201ZC3		VE18 VE19 VE27	EA

<b>OEM Part #</b>	<b>Epic No.</b>	<b>Description</b>	<b>Page</b>	
301650	EE305540	Bearing, Ball, 6201, for ICBT N Spindle	VE20	EA
				
301651	EE305541	Bearing, Ball, 6202, for ICBT N Spindle	VE20	EA
				
311605	EE304390	Pulley, Tape Tension (50mm) for Model 450	VE17	EA
				
311607	EE304400	Pulley, Tape Tension (70mm) for Model 400 & 500	VE17	EA
				
318580	EE304540	O-Ring for Spindle Housing	VE01 VE01A VE18 VE27	EA
				
318581	EE309044	O-Ring 9.5 X 1.5mm	VE01 VE18 VE19 VE20	EA
				
318597	EE304480	O-Ring, R Base	VE01 VE01A VE18 VE19	EA
				
318598	EE304500	O-Ring, Top Bearing Upper	VE01 VE01A VE05A VE18 VE19 VE20	EA
				
318603	EE304530	O-Ring 35 X 1.6	VE01 VE02A VE05A VE19	EA
				

<b>OEM Part #</b>	<b>Epic No.</b>	<b>Description</b>	<b>Page</b>	
(318625)	EE303435	O-Ring, Small, Internal, for 450 Base Shell and ICBT Base Shell	VE07	EA
				
318669	EE380193	Seal Ring for Brake Piston, ICBT N-Spindle	VE20	EA
				
318976	EE380178	Pre-Take-Up/Overfeed, O-Ring, ICBT Type	VE25	EA
				
318993	EE304460	O-Ring, Top Bearing Lower	VE01 VE01A	EA
				
3202	EE304222	Bearing, R Spindle Housing, Double Seal, 3202.2RS	VE01A VE18	EA
				
(331593)	EE304340	Tape, Spindle Drive, .63 X 40.5" (16mmX1030mm), 450 and ICBT	VE17	EA
				
(331631)	EE304340	Tape, Spindle Drive, .63 X 40.5" (16mmX1030mm), 450 and ICBT	VE17	EA
				
(338146)	EE309071	Spring Plunger, with Ball End, 5mm	VE21	EA
				
354797	EE309090	Fitting, Grease, for Verdol Spindle Housing and Base Cap	VE01 VE01A VE18 VE19	EA
				

EE is an Epic trademark designating Epic parts

Verdol is a trademark of Rieter/ ICBT

© Epic Enterprises, April 2009

Epic products are intended as replacements for worn or damaged parts in OEM products. OEM Part numbers in (parenthesis) indicate either 1) Improved design 2) the part serves the same function as the OEM part, but may differ from the OEM design, or 3) it is a component of an assembly where no OEM reference number is available, or 4) it is a repair service for the referenced OEM part.

<b>OEM Part #</b>	<b>Epic No.</b>	<b>Description</b>	<b>Page</b>	
(363147)	EE309069-2	Eyelet, Flanged Red	VE21	EA 
363370	EE309030	Eyelet, Ceramic, for 450 Pot Yarn Brake Assembly		EA 
363375	EE401480V	Traverse Thread Guide Ceramic Tip, 3.0mm	VE10	EA 
363400	EE309120	Ceramic Eye for ICBT Balloon Guide, CD-DT		EA 
(440062)	EE380152	Blade, ICBT Cutter (100/Box)		BX 
(440114C)-SKF	EE304242	Bearing, R Whorl, NTN	VE01 VE01A VE18	EA 
49202902	EE380238	Bushing, 60mm, for ICBT Creel		EA 
50324100	EE380179	Pre-Take-Up/Overfeed, Washer, ICBT Type	VE25	EA 
520012A	EE303680	Screw, Upper Cylinder	VE01	EA 

EE is an Epic trademark designating Epic parts

Verdol is a trademark of Rieter/ ICBT

© Epic Enterprises, April 2009

Epic products are intended as replacements for worn or damaged parts in OEM products. OEM Part numbers in (parenthesis) indicate either 1) Improved design 2) the part serves the same function as the OEM part, but may differ from the OEM design, or 3) it is a component of an assembly where no OEM reference number is available, or 4) it is a repair service for the referenced OEM part.

<i>OEM Part #</i>	<i>Epic No.</i>	<i>Description</i>	<i>Page</i>	
520021A	EE303700	Screw, Hex Head Cap, 5X10	VE01A	EA
				
520022A	EE303720	Screw, Hex Head Cap, 5X25	VE01	EA
				
520024A	EE303720-1	Screw, Hex Head Cap, 5X40	VE18 VE19	EA
				
52030C00	EE380141	Magnet, for Verdol F44, RM and ICBT	VE18 VE19 VE20 VE28 VE28A	EA
				
524501B	EE330358	Screw, Socket Head Cap, 5X25, Zinc Plated	VE27	EA
				
524509B	EE303760	Screw, Socket Head Cap, 5X16	VE01 VE01A VE02 VE18 VE19	EA
				
(524509B)	EE401876V	Screw, Socket Head Cap 5X16	VE10	EA
				
524513B	EE430220V	Screw, Socket Head Cap 6X10	VE27	EA
				
524514	EE303613	Screw, Socket Head Cap, 6X16	VE09 VE27	EA
				









<b>OEM Part #</b>	<b>Epic No.</b>	<b>Description</b>	<b>Page</b>	
524515	EE303609	Screw, Socket Head Cap, 6X20	VE09	EA
				
524518	EE303760-1	Screw, Socket Head Cap, 5X25	VE20	EA
				
524518B	EE430227V	Screw, Socket Head Cap 6X30	VE10	EA
				
524524B	EE330234	Screw, Socket Head Cap, 6 X 75	VE09	EA
				
524551B	EE303760-1	Screw, Socket Head Cap, 5X25	VE20	EA
				
524600B	EE330350	Screw, Socket Head Cap, Zinc Plated, 6X 35	VE22	EA
				
536028B	EE303780	Screw, Hex Socket Cone Point Set, 6X12	VE01 VE18 VE19	EA
				
536604B	EE303780	Screw, Hex Socket Cone Point Set, 6X12	VE01 VE18 VE19	EA
				
53862500	EE380176	Pre-Take-Up/Overfeed, Male Half, ICBT Type	VE25	EA
				

EE is an Epic trademark designating Epic parts

Verdol is a trademark of Rieter/ ICBT

© Epic Enterprises, April 2009

Epic products are intended as replacements for worn or damaged parts in OEM products. OEM Part numbers in (parenthesis) indicate either 1) Improved design 2) the part serves the same function as the OEM part, but may differ from the OEM design, or 3) it is a component of an assembly where no OEM reference number is available, or 4) it is a repair service for the referenced OEM part.









<i>OEM Part #</i>	<i>Epic No.</i>	<i>Description</i>	<i>Page</i>	
53862600	EE380177	Pre-Take-Up/Overfeed, Female Half, ICBT Type	VE25	EA 
547515H	EE309041	Screw for Eyelet Holder	VE20	EA 
549509	EE303790	Lock Nut, Nylon Insert, 6mm	VE09	EA 
549509A	EE333350	Nut, Hex, Zinc Plated, 6mm	VE22	EA 
555002A	EE303800	Washer, for Cam and Handle	VE01A	EA 
555004A	EE432803V	Washer, Large OD Flat, 8mm		EA 
555024A	EE431602V	Washer, Regular Flat, 8mm	VE09	EA 
(555024A)	A-18356	Washer, Regular Flat 3/8", Plated	VE09 VE14 VE15 VE16 VE23	EA 
555036A	EE303820	Washer, Regular Flat, 4mm	VE01	EA 

EE is an Epic trademark designating Epic parts

Verdol is a trademark of Rieter/ ICBT

© Epic Enterprises, April 2009

Epic products are intended as replacements for worn or damaged parts in OEM products. OEM Part numbers in (parenthesis) indicate either 1) Improved design 2) the part serves the same function as the OEM part, but may differ from the OEM design, or 3) it is a component of an assembly where no OEM reference number is available, or 4) it is a repair service for the referenced OEM part.

<b>OEM Part #</b>	<b>Epic No.</b>	<b>Description</b>	<b>Page</b>	
555047A	EE303840	Washer, External Serrated Lock, 4mm	VE01	EA
				
555048A	EE303860	Washer, External Serrated Lock, 5mm (Unplated)	VE01 VE01A VE02 VE10 VE18 VE19	EA
				
555062A	EE432502V	Lockwasher, Split, 6mm	VE10	EA
				
555062S	EE332502	Lockwasher, Split, 6mm	VE22	EA
				
558002A	EE303880	Ring, External Retaining, (10E or C1.010)	VE01 VE01A VE18 VE19	EA
				
558005A	EE303900	Ring, External, Retaining, (15E or C1.015)	VE01 VE01A VE18	EA
				
558006A	EE304040	Ring, External Retaining, 16mm (16E or C1.016)	VE01 VE01A VE02 VE18 VE19	EA
				
558024A	EE304680	Ring, Internal Retaining, 28mm		EA
				
558026A	EE334305	Ring, Internal Retaining, 32mm	VE05A VE27	EA
				



<b>OEM Part #</b>	<b>Epic No.</b>	<b>Description</b>	<b>Page</b>	
558027A	EE304020	Ring, R Whorl Retaining (35l or C2.035)	VE01 VE01A VE18	EA
558043A	EE304680	Ring, Internal Retaining, 28mm		EA
558044A	EE304045	Ring, Internal Retaining (30l)	VE01 VE01A	EA
(558044A)	EE304045-1	Ring, Retaining, for Top Bearing Housing Assembly (Metric)		EA
558063A	EE304060	Ring, Cylinder Retaining (I 16K)	VE01 VE01A	EA
558082A	EE434228V	Ring, External Retaining, 42X1.75	VE18 VE19 VE20 VE27	EA
559504A	EE304080	Pin, Cylinder Roll, 3X10mm	VE01 VE01A	EA
561031A	EE309042	Rivet, Aluminum, 2.5 X 8mm	VE27	EA
562500A	EE438000V	Screw, Slotted Pan Head Tapping, 2.9x9.5	VE19	EA

EE is an Epic trademark designating Epic parts

Verdol is a trademark of Rieter/ ICBT

© Epic Enterprises, April 2009

Epic products are intended as replacements for worn or damaged parts in OEM products. OEM Part numbers in (parenthesis) indicate either 1) Improved design 2) the part serves the same function as the OEM part, but may differ from the OEM design, or 3) it is a component of an assembly where no OEM reference number is available, or 4) it is a repair service for the referenced OEM part.

<b>OEM Part #</b>	<b>Epic No.</b>	<b>Description</b>	<b>Page</b>	
569009S	EE304100	Bearing, U Spindle Base, 6301	VE02	EA 
569013S	EE304120	Bearing, Upper Oblique, 16004C3	VE01 VE01A	EA 
569016S	EE304140	Bearing, Lower Oblique, 6005C3	VE01 VE01A	EA 
(569016S)	EE304144	Bearing, Lower Oblique, 6005-2RSC3	VE01A	EA 
(569027SS)	EE304202	Bearing, Top, 5200, Double Seal	VE01 VE01A	EA 
(569027SS)	EE304202-1	Bearing, Top, Steel Cage, 5200, without seals (Note: Do not use EE302120 Washer. And, Use EE302081 modified washer in place of EE302080 washer).	VE01 VE01A	EA 
569028R	EE304222	Bearing, R Spindle Housing, Double Seal, 3202.2RS	VE01A VE18	EA 
569028S	EE304220	Bearing, R Spindle Housing, 3202 with Steel Cage	VE01 VE01A	EA 
569061B	EE304242	Bearing, R Whorl, NTN	VE01 VE01A VE18	EA 

EE is an Epic trademark designating Epic parts

Verdol is a trademark of Rieter/ ICBT

© Epic Enterprises, April 2009

Epic products are intended as replacements for worn or damaged parts in OEM products. OEM Part numbers in (parenthesis) indicate either 1) Improved design 2) the part serves the same function as the OEM part, but may differ from the OEM design, or 3) it is a component of an assembly where no OEM reference number is available, or 4) it is a repair service for the referenced OEM part.









<b>OEM Part #</b>	<b>Epic No.</b>	<b>Description</b>	<b>Page</b>	
569063S	EE304260	Bearing, R& RM Spindle Base, 6200 (Open)	VE01 VE01A VE18 VE19	EA 
(569063S)	EE304262	Bearing, R & RM Spindle Base, 6200-2RS, (Double Seal)	VE01A VE18	EA 
(569063S)	EE304262-1	Bearing, R & RM Spindle Base, 6200-2RS, (Double Seal), SKF	VE01A VE18	EA 
569081D	EE304280	Bearing, Ball, 6202ZZ	VE05A VE18 VE19 VE20 VE27	EA 
569082D	EE304300	Bearing, N Spindle, 450, 6201ZC3	VE18 VE19 VE27	EA 
(569082D)	EE304300-1	Bearing, Ball, with two metal shields, 6201ZC3HT51 SKF	VE05A VE18 VE19 VE20 VE27	EA 
569094D	EE309032	Bearing for Roller Assembly EE380020	VE22	EA 
569103D	EE309046	Bearing, F44 Bottom Housing (6300)	VE19	EA 
569116D	EE304245	Bearing, Whorl, for F44, 63203	VE19	EA 





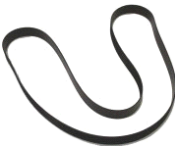
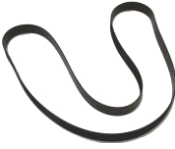



EE is an Epic trademark designating Epic parts

Verdol is a trademark of Rieter/ ICBT

© Epic Enterprises, April 2009

Epic products are intended as replacements for worn or damaged parts in OEM products. OEM Part numbers in (parenthesis) indicate either 1) Improved design 2) the part serves the same function as the OEM part, but may differ from the OEM design, or 3) it is a component of an assembly where no OEM reference number is available, or 4) it is a repair service for the referenced OEM part.

<b>OEM Part #</b>	<b>Epic No.</b>	<b>Description</b>	<b>Page</b>	
569160D	EE304245	Bearing, Whorl, for F44, 63203	VE19	EA
				
5700000	EE304400	Pulley, Tape Tension (70mm) for Model 400 & 500	VE17	EA
				
574061A	EE304320	Tape, Spindle Drive, .75X112" (19mmX2845mm)	VE17	EA
				
574093A	EE304320	Tape, Spindle Drive, .75X112" (19mmX2845mm)	VE17	EA
				
574120B	EE304340	Tape, Spindle Drive, .63 X 40.5" (16mmX1030mm), 450 and ICBT	VE17	EA
				
574128B	EE304340	Tape, Spindle Drive, .63 X 40.5" (16mmX1030mm), 450 and ICBT	VE17	EA
				
574137A	EE304344	Tape, Spindle Drive, .75X120" (20mmX3040mm)	VE17	EA
				
576025A	EE304390	Pulley, Tape Tension (50mm) for Model 450	VE17	EA
				
576026S	EE304400	Pulley, Tape Tension (70mm) for Model 400 & 500	VE17	EA
				

<b>OEM Part #</b>	<b>Epic No.</b>	<b>Description</b>	<b>Page</b>	
580000A	EE304420	Washer, Cylinder Wave	VE01	EA
				
580006A	EE380166	Washer, Wave, for RM, F44 & ICBT N Spindle	VE18 VE19 VE20 VE27	EA
				
580050A	EE304450	Lock Nut, Nylon Insert Hex, 8mm	VE09	EA
				
580109A	EE304448	Washer, Spacer, for RM, F44 & ICBT N Spindle	VE18 VE19 VE20 VE27	EA
				
581011C	EE304460	O-Ring, Top Bearing Lower	VE01 VE01A	EA
				
581012C	EE304480	O-Ring, R Base	VE01 VE01A VE18 VE19	EA
				
581013B	EE304500	O-Ring, Top Bearing Upper	VE01 VE01A VE05A VE18 VE19 VE20	EA
				
581021C	EE304520-1	O-Ring, Cylinder for EE302780 Nylon Cylinder Plug	VE01 VE01A	EA
				
(581021C)	EE309044	O-Ring 9.5 X 1.5mm	VE01 VE18 VE19 VE20	EA
				



<i>OEM Part #</i>	<i>Epic No.</i>	<i>Description</i>	<i>Page</i>	
581057A	EE309090	Fitting, Grease, for Verdol Spindle Housing and Base Cap	VE01 VE01A VE18 VE19	EA 
(581057A)	EE304535	Fitting, Grease, for R Spindle Base	VE01 VE01A	EA 
581158C	EE304540	O-Ring for Spindle Housing	VE01 VE01A VE18 VE27	EA 
581188C	EE304530	O-Ring 35 X 1.6	VE01 VE02A VE05A VE19	EA 
582189A	EE304390	Pulley, Tape Tension (50mm) for Model 450	VE17	EA 
583008A	EE304550	Bushing, Take-Up Shaft	VE12	EA 
(583058)	EE304760	Kit, Repair, E Creel Arm (A-18165) (2 Bushings in Steel Shell)	VE14	EA 
583058A	EE304560	Bushing, E Creel Arm	VE14	EA 
588003A	EE304640	Ring, External Retaining (12E or C1.012)	VE02 VE20	EA 

EE is an Epic trademark designating Epic parts

Verdol is a trademark of Rieter/ ICBT

© Epic Enterprises, April 2009

Epic products are intended as replacements for worn or damaged parts in OEM products. OEM Part numbers in (parenthesis) indicate either 1) Improved design 2) the part serves the same function as the OEM part, but may differ from the OEM design, or 3) it is a component of an assembly where no OEM reference number is available, or 4) it is a repair service for the referenced OEM part.

<b>OEM Part #</b>	<b>Epic No.</b>	<b>Description</b>	<b>Page</b>	
(588016)	EE380020	Roller, V-Groove Assembly	VE16 VE22	EA 
588017A	EE380149	Disc, Tension, for Verdol Cabler Cap Tension Device	VE08A	EA 
588034A	EE304580	Eyelet, Small Ceramic	VE08 VE08A VE14 VE15 VE16	EA 
588034C	EE304600	Eyelet, Large Ceramic	VE14	EA 
588049A	EE309030	Eyelet, Ceramic, for 450 Pot Yarn Brake Assembly		EA 
6005C3	EE304140	Bearing, Lower Oblique, 6005C3	VE01 VE01A	EA 
62012ZC3HT5 1	EE304300-1	Bearing, Ball, with two metal shields, 62012ZC3HT51 SKF	VE05A VE18 VE19 VE20 VE27	EA 
6201ZC3	EE304300	Bearing, N Spindle, 450, 6201ZC3	VE18 VE19 VE27	EA 
6301	EE304100	Bearing, U Spindle Base, 6301	VE02	EA 

EE is an Epic trademark designating Epic parts

Verdol is a trademark of Rieter/ ICBT

© Epic Enterprises, April 2009

Epic products are intended as replacements for worn or damaged parts in OEM products. OEM Part numbers in (parenthesis) indicate either 1) Improved design 2) the part serves the same function as the OEM part, but may differ from the OEM design, or 3) it is a component of an assembly where no OEM reference number is available, or 4) it is a repair service for the referenced OEM part.

<b>OEM Part #</b>	<b>Epic No.</b>	<b>Description</b>	<b>Page</b>	
90201702	EE380148	Plate, Lower Magnet, with Magnets for Verdol RM, F44 Spindle	VE18 VE19 VE27	EA
(90801100)	EE309097	Recoat ICBT Conveyor Drive Roll		EA
920001800	EE380141	Magnet, for Verdol F44, RM and ICBT	VE18 VE19 VE20 VE28 VE28A	EA
92000800	EE380106	Hub for N Spindle, 450	VE27	EA
92001100	EE380197	Housing, Lower, for "N" Spindle	VE27	EA
92001500	EE380164	Wire Keeper for RM, F44 & ICBT N Spindle	VE18 VE19 VE20 VE27	EA
92001802	EE380141	Magnet, for Verdol F44, RM and ICBT	VE18 VE19 VE20 VE28 VE28A	EA
(92002000)	EE380144	Plate, Upper Magnet, with Magnets for Verdol Spindles, RM, F44, & ICBT	VE18 VE19 VE20	EA
92002400	EE380172	Eyelet, Ceramic, for ICBT N Spindle	VE20 VE27	EA







EE is an Epic trademark designating Epic parts

Verdol is a trademark of Rieter/ ICBT

© Epic Enterprises, April 2009

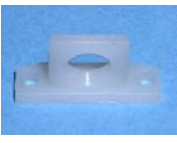
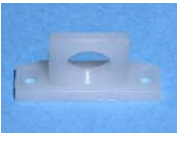
Epic products are intended as replacements for worn or damaged parts in OEM products. OEM Part numbers in (parenthesis) indicate either 1) Improved design 2) the part serves the same function as the OEM part, but may differ from the OEM design, or 3) it is a component of an assembly where no OEM reference number is available, or 4) it is a repair service for the referenced OEM part.



<b>OEM Part #</b>	<b>Epic No.</b>	<b>Description</b>	<b>Page</b>	
92002500	EE380173	Guide, Two Way, Channel for ICBT N Spindle	VE20 VE27	EA 
92003000	EE309040	Eyelet, Ceramic,for Reserve Disc	VE18 VE19 VE20	EA 
92003100	EE380059	Eyelet Retaining Piece for Hub/Reserve	VE18 VE19 VE20	EA 
92003101	EE380059	Eyelet Retaining Piece for Hub/Reserve	VE18 VE19 VE20	EA 
92003702	EE380170	Hub, Aluminum, for ICBT Spindle	VE20	EA 
92003706	EE380170	Hub, Aluminum, for ICBT Spindle	VE20	EA 
92003803	EE380168	Bearing Housing, Upper, for ICBT N Spindle (Shell Only- Old Style Housing - Does not include O-Ring - See EE340055 for Assembly)	VE20	EA 
(92003803)	EE340055	Bearing Housing Assembly, Upper, ICBT N Spindle (with O-Ring, Wave Washer and Wire Keeper--See EE380168 for Shell Only)	VE20	EA 
92003900	EE309072-0	Capsule, Tension #0 for Verdol	VE07	EA 









EE is an Epic trademark designating Epic parts

Verdol is a trademark of Rieter/ ICBT

© Epic Enterprises, April 2009

Epic products are intended as replacements for worn or damaged parts in OEM products. OEM Part numbers in (parenthesis) indicate either 1) Improved design 2) the part serves the same function as the OEM part, but may differ from the OEM design, or 3) it is a component of an assembly where no OEM reference number is available, or 4) it is a repair service for the referenced OEM part.

<b>OEM Part #</b>	<b>Epic No.</b>	<b>Description</b>	<b>Page</b>	
92004602	EE380219	Sleeve for F44 Spindle Housing, New Style (Use with VE19-06A and VE19-06C)	VE19	EA
				
92004700	EE340069	Housing, New F44 Spindle, with Grease Fitting	VE19	EA
				
(92004800)	EE303216-2	Deflector with Hub, 175mm, for New Type F44 Spindle	VE19	EA
(92004800)	EE303217-1	Deflector with Hub, 160mm, for New Type F44 Spindle	VE19	EA
92005802	EE380171	Bearing Housing, Lower, for ICBT N Spindle	VE20	EA
				
92005803	EE380171	Bearing Housing, Lower, for ICBT N Spindle	VE20	EA
				
92006602	EE380192	Brake Piston for ICBT N-Spindle	VE20	EA
				
92006800	EE309115	Eyelet Assembly	VE20	EA
				
(92009000)	EE309045	Spindle, Rebuild Customer F44 CONTACT EPIC FOR PRICING	VE04 VE19	EA
				

<b>OEM Part #</b>	<b>Epic No.</b>	<b>Description</b>	<b>Page</b>	
92009400	EE380160	Axle, ICBT N Spindle	VE20	EA 
92009500	EE380169	Whorl, ICBT N Spindle	VE20	EA 
92009502	EE380169	Whorl, ICBT N Spindle	VE20	EA 
92009600	EE380163	Nut, ICBT Spindle	VE20	EA 
92009700	EE380205	Axle and Box Assembly	VE20	EA 
(9201220)	EE380144-1	Plate, Upper Magnet, with Magnet & Grommet for Verdol Spindles, RM, F44, & ICBT	VE18 VE19 VE20 VE27	EA 
92012202	EE380144	Plate, Upper Magnet, with Magnets for Verdol Spindles, RM, F44, & ICBT	VE18 VE19 VE20	EA 
92012401	EE380142	Grommet, Urethane, for Magnet Plate, Verdol RM, F44 & ICBT	VE18 VE19 VE20	EA 
92013401	EE340055	Bearing Housing Assembly, Upper, ICBT N Spindle (with O-Ring, Wave Washer and Wire Keeper--See EE380168 for Shell Only)	VE20	EA 

EE is an Epic trademark designating Epic parts

Verdol is a trademark of Rieter/ ICBT

© Epic Enterprises, April 2009

Epic products are intended as replacements for worn or damaged parts in OEM products. OEM Part numbers in (parenthesis) indicate either 1) Improved design 2) the part serves the same function as the OEM part, but may differ from the OEM design, or 3) it is a component of an assembly where no OEM reference number is available, or 4) it is a repair service for the referenced OEM part.









<b>OEM Part #</b>	<b>Epic No.</b>	<b>Description</b>	<b>Page</b>	
92014701	EE309095	Capsule, Tension, #2, Bulb Type for ICBT	VE07	EA
				
(92014701)	EE309095A	Capsule, Tension, #3, Bulb Type for ICBT	VE07	EA
				
92018201	EE380223	Magnet Plate Assembly for ICBT Pot	VE28 VE28A	EA
				
(92025200)	EE340048	Repair, of Threading Channel 200mm, and Balance	VE18 VE19 VE20	EA
				
920252000	EE340051	Disc and Reserve Assembly, Stainless, 280 X 200mm, ICBT	VE18 VE19 VE20	EA
				
92025800	EE309095	Capsule, Tension, #2, Bulb Type for ICBT	VE07	EA
				
(92061802)	EE380141	Magnet, for Verdol F44, RM and ICBT	VE18 VE19 VE20 VE28 VE28A	EA
				
92500400	EE303612	Plate, Centering Guide Fitting	VE09	EA
				
92500500	EE303610	Stud, Short Guide Holder for EE303614	VE09	EA
				

EE is an Epic trademark designating Epic parts

Verdol is a trademark of Rieter/ ICBT

© Epic Enterprises, April 2009

Epic products are intended as replacements for worn or damaged parts in OEM products. OEM Part numbers in (parenthesis) indicate either 1) Improved design 2) the part serves the same function as the OEM part, but may differ from the OEM design, or 3) it is a component of an assembly where no OEM reference number is available, or 4) it is a repair service for the referenced OEM part.

<b>OEM Part #</b>	<b>Epic No.</b>	<b>Description</b>	<b>Page</b>	
92501003	EE302040	Spring, Spindle for R, U, & G Spindle (also used for Balloon Centering Guide)	VE01 VE01A VE09 VE18 VE19	EA 
93007400	EE380225	Cap, Bottom Housing, with O-Rings and Grease Fitting, F44	VE19	EA 
(93214803)	EE380174	Shell Only, PTU/Over Feed, 14 Flute, Open-Type, Ceramic Coated, for ICBT	VE25	EA 
93402900	EE305545	Friction Roller Assembly, ICBT and Verdol 450 with Full Length Cot	VE24	EA 
(93402900)	EE309103	Strip Customer Verdol 450 or ICBT Friction Roll and install Full Length Cot EE305542 (Minimum 12 pieces)	VE24	EA 
93402902	EE305545	Friction Roller Assembly, ICBT and Verdol 450 with Full Length Cot	VE24	EA 
(93402902)	EE305550	Install Epic Full Length Cot EE305542 on Customer's Cotless Roll, ICBT and Verdol 450 (Minimum 12 pieces)	VE24	EA 
93500201	EE380151	Bracket, Traverse Guide, ICBT		EA 
935112	EE304320	Tape, Spindle Drive, .75X112" (19mmX2845mm)	VE17	EA 

EE is an Epic trademark designating Epic parts

Verdol is a trademark of Rieter/ ICBT

© Epic Enterprises, April 2009

Epic products are intended as replacements for worn or damaged parts in OEM products. OEM Part numbers in (parenthesis) indicate either 1) Improved design 2) the part serves the same function as the OEM part, but may differ from the OEM design, or 3) it is a component of an assembly where no OEM reference number is available, or 4) it is a repair service for the referenced OEM part.

<b>OEM Part #</b>	<b>Epic No.</b>	<b>Description</b>	<b>Page</b>	
93515100	EE380240	Roller, Guide, for ICBT Traverse Rod, Bottom, Small		EA
				
93515500	EE380241	Roller, Guide, for ICBT Traverse Rod, Top, Small		EA
				
935283	EE304320	Tape, Spindle Drive, .75X112" (19mmX2845mm)	VE17	EA
				
94001300	EE380125	Bracket for Mounting Storage Tensor to ICBT Twister (without Ceramics)	VE21	EA
				
(94001300)	EE380126	Mounting Bracket with Ceramic Eyes	VE21	EA
				
(94208300)	EE380203	Cover, Safety for Heavy Duty ICBT Creel Spring 94208300		EA
				
94209901	EE309111	Spring, ICBT Creel, Right Side		EA
				
(94209901)	EE380201	Cover, Safety for ICBT Creel Spring 94209901		EA
				
94403801	EE309070	Pin, Ceramic, Pink, 2.5mm Diameter	VE21	EA
				







<b>OEM Part #</b>	<b>Epic No.</b>	<b>Description</b>	<b>Page</b>	
(94403801)	EE309070-1	Pin, Ceramic, Pink, 3.5mm diameter	VE21	EA
				
94700600	EE380022	Roller, V-Groove for Roller Assembly EE380020	VE22	EA
				
94700601	EE380022	Roller, V-Groove for Roller Assembly EE380020	VE22	EA
				
950612	EE303780	Screw, Hex Socket Cone Point Set, 6X12	VE01 VE18 VE19	EA
				
(962031800)	EE309127	Pot, Customer, Repaired, Stainless Steel Bottom, for 260mm Disc, ICBT, DT/CD	VE28 VE28A	EA
				
(962036B00)	EE309129	Pot, Customer, Repaired, Stainless Steel Bottom, for 280mm Disc, ICBT, DT/CD	VE28 VE28A	EA
				
(962037A01)	EE309129	Pot, Customer, Repaired, Stainless Steel Bottom, for 280mm Disc, ICBT, DT/CD	VE28 VE28A	EA
				
(962042A01)	EE309129	Pot, Customer, Repaired, Stainless Steel Bottom, for 280mm Disc, ICBT, DT/CD	VE28 VE28A	EA
				
96301800	EE340024	Pot Lid, Stainless Steel, for 290mm Pot	VE08 VE08A VE28 VE28A	EA
				

EE is an Epic trademark designating Epic parts









Verdol is a trademark of Rieter/ ICBT

© Epic Enterprises, April 2009

Epic products are intended as replacements for worn or damaged parts in OEM products. OEM Part numbers in (parenthesis) indicate either 1) Improved design 2) the part serves the same function as the OEM part, but may differ from the OEM design, or 3) it is a component of an assembly where no OEM reference number is available, or 4) it is a repair service for the referenced OEM part.

<b>OEM Part #</b>	<b>Epic No.</b>	<b>Description</b>	<b>Page</b>	
96500200	EE302245	Pad, Felt, Unlined, 273mm OD X 90mm ID X 8mm Thick, Gray (10 3/4" X 3 1/2" X 5/16")	VE14 VE15 VE28 VE28A	EA 
96500300	EE302243	Pad, Foam, Unlined, 280mm OD X 90mm ID X 15mm Thick, White (11" X 3 1/2" X 5/8")	VE14 VE15 VE28A	EA 
96700700	EE480112V	Number Strip for Multi-Tension Device		EA 
96701801	EE380021	Cap, End for Roller Assembly EE380020	VE22	EA 
96705000	EE309056	Eyelet, Ceramic Tube, Tan	VE27	EA 
96900401	EE380211	Locking Nut for ICBT Base Shell, CD-DT	VE28 VE28A	EA 
96900800	EE303502	Clip, Yarn, for Overfeed Cover	VE11 VE16	EA 
96901600	EE302060	Washer, Large Rubber for 400 Base Shell and ICBT Base Shell	VE05A VE07 VE28 VE28A	EA 
96901800	EE380021	Cap, End for Roller Assembly EE380020	VE22	EA 



<b>OEM Part #</b>	<b>Epic No.</b>	<b>Description</b>	<b>Page</b>	
96906800	EE380210	Base Shell, Only, for ICBT, CD-DT	VE28 VE28A	EA 
96906801	EE380210	Base Shell, Only, for ICBT, CD-DT	VE28 VE28A	EA 
96906802	EE380210	Base Shell, Only, for ICBT, CD-DT	VE28 VE28A	EA 
96906900	EE380212	Washer, Urethane, for ICBT Base Shell, CD-DT	VE28 VE28A	EA 
B92009700	EE380205	Axle and Box Assembly	VE20	EA 
(BP12x20x290 5)	EE304550	Bushing, Take-Up Shaft	VE12	EA 
BSR51	EE304390	Pulley, Tape Tension (50mm) for Model 450	VE17	EA 
BSR72	EE304400	Pulley, Tape Tension (70mm) for Model 400 & 500	VE17	EA 
C1010	EE303880	Ring, External Retaining, (10E or C1.010)	VE01 VE01A VE18 VE19	EA 

EE is an Epic trademark designating Epic parts

Verdol is a trademark of Rieter/ ICBT

© Epic Enterprises, April 2009

Epic products are intended as replacements for worn or damaged parts in OEM products. OEM Part numbers in (parenthesis) indicate either 1) Improved design 2) the part serves the same function as the OEM part, but may differ from the OEM design, or 3) it is a component of an assembly where no OEM reference number is available, or 4) it is a repair service for the referenced OEM part.

OEM Part #	Epic No.	Description		Page	
C1012	EE304640	Ring, External Retaining (12E or C1.012)		VE02 VE20	EA
C1015	EE303900	Ring, External, Retaining, (15E or C1.015)		VE01 VE01A VE18	EA
C1016	EE304040	Ring, External Retaining, 16mm (16E or C1.016)		VE01 VE01A VE02 VE18 VE19	EA
C2035	EE304020	Ring, R Whorl Retaining (35I or C2.035)		VE01 VE01A VE18	EA
CHC5	EE303760-1	Screw, Socket Head Cap, 5X25		VE20	EA
DE4	EE303840	Washer, External Serrated Lock, 4mm		VE01	EA
DE5	EE303860	Washer, External Serrated Lock, 5mm (Unplated)		VE01 VE01A VE02 VE10 VE18 VE19	EA
DF0213LLU/15 A	EE304242	Bearing, R Whorl, NTN		VE01 VE01A VE18	EA
HICM5X16	EE303760	Screw, Socket Head Cap, 5X16		VE01 VE01A VE02 VE18 VE19	EA









EE is an Epic trademark designating Epic parts









Verdol is a trademark of Rieter/ ICBT









© Epic Enterprises, April 2009

Epic products are intended as replacements for worn or damaged parts in OEM products. OEM Part numbers in (parenthesis) indicate either 1) Improved design 2) the part serves the same function as the OEM part, but may differ from the OEM design, or 3) it is a component of an assembly where no OEM reference number is available, or 4) it is a repair service for the referenced OEM part.

<b>OEM Part #</b>	<b>Epic No.</b>	<b>Description</b>	<b>Page</b>	
HICM5X16	EE401876V	Screw, Socket Head Cap 5X16	VE10	EA
				
HICM5X25	EE303760-1	Screw, Socket Head Cap, 5X25	VE20	EA
				
HICM6X20	EE303609	Screw, Socket Head Cap, 6X20	VE09	EA
				
HICM6X30	EE430227V	Screw, Socket Head Cap 6X30	VE10	EA
				
HICM6X35	EE430228V	Screw, Socket Head Cap 6X35		EA
				
HICM6X75	EE330234	Screw, Socket Head Cap, 6 X 75	VE09	EA
				
HM4X12	EE303680	Screw, Upper Cylinder	VE01	EA
				
HM5X25	EE303720	Screw, Hex Head Cap, 5X25	VE01	EA
				
HM5X40	EE303720-1	Screw, Hex Head Cap, 5X40	VE18 VE19	EA
				

<b>OEM Part #</b>	<b>Epic No.</b>	<b>Description</b>	<b>Page</b>	
HU6	EE433301V	Nut, Hex, 5mm	VE10	EA
				
HUM6	EE303790	Lock Nut, Nylon Insert, 6mm	VE09	EA
				
HUM6	EE333350	Nut, Hex, Zinc Plated, 6mm	VE22	EA
				
LU5	EE303800	Washer, for Cam and Handle	VE01A	EA
				
Not Applicable	A-18043	Support, Main Creel (Post)	VE14	EA
				
Not Applicable	A-18044	Shaft, 1X24"	VE14	EA
				
Not Applicable	A-18046	Shaft, 3/4" X 24"	VE14	EA
				
Not Applicable	A-18057	Support, Channel, 4"	VE16	EA
				
Not Applicable	A-18058	Spacer, Heavy Wall	VE16	EA
				

<b>OEM Part #</b>	<b>Epic No.</b>	<b>Description</b>	<b>Page</b>	
Not Applicable	A-18060	Cover, Spindle Dust (Aluminum)		EA
				
Not Applicable	A-18173	Bolt, Carriage, 3/8" X 9.5"	VE15	EA
				
Not Applicable	A-18232	Cover, End 400mm, Right Side, Gear End	VE11	EA
				
Not Applicable	A-18233	Cover, End 400mm, Left Side, Gear End	VE11	EA
				
Not Applicable	A-18234	Cover, End 400mm, Right Side, Motor End	VE11	EA
				
Not Applicable	A-18235	Cover, End 400mm, Left Side, Motor End	VE11	EA
				
Not Applicable	A-18280	Handle, Yellow Vinyl for E Creel	VE14	EA
				
Not applicable	A-18328	Pads, EpiBrite for removing scratches on pots and balloon rings (100 pads/case)	VE07	EA
				
Not Applicable	A-18357	Lock Washer, Spring, 3/8", Z/P	VE14 VE15 VE16	EA
				

<b>OEM Part #</b>	<b>Epic No.</b>	<b>Description</b>	<b>Page</b>	
Not Applicable	A-18358	Nut, Hex , 3/8" Z/P	VE14 VE15 VE16	EA 
Not Applicable	A-18359	Collar w/Set Screw, 3/4"	VE14	EA 
Not Applicable	A-18360	Collar w/Set Screw, 1"	VE14	EA 
Not Applicable	A-18362	Bolt, Carriage, 3/8" X 8"	VE14	EA 
Not Applicable	A-18364	Lockwasher, 1/4, Z/P	VE14 VE16	EA 
Not Applicable	A-18365	Nut, Hex, 1/4", Z/P	VE14 VE16	EA 
Not Applicable	A-18367	Plate, Slide for E Creel Latch	VE14	EA 
Not Applicable	A-18368	Spacer for E Creel Latch	VE14	EA 
Not Applicable	A-18370	Lock Nut, Nylon Insert, 5/16", Z/P	VE14	EA 

<b>OEM Part #</b>	<b>Epic No.</b>	<b>Description</b>	<b>Page</b>	
Not Applicable	A-18371	Screw, Hex Head Cap, 5/16" x 3/4"	VE14	EA
				
Not Applicable	A-18374	Screw, Hex Head Cap, 3/8" x 3/4"	VE16	EA
				
Not Applicable	A-18375	Screw, Hex Head Cap, 3/8" x 1", Z/P	VE16	EA
				
Not Applicable	A-18376	Screw, Hex Head Cap, 3/8" x 3/4", Z/P	VE16	EA
				
Not Applicable	A-18377	Screw, Hex Head Cap, 1/4" x 1/2" ZP	VE16	EA
				
Not Applicable	A-18436V	Lock Nut, Nylon Insert, Z/P, 5mm	VE08	EA
				
Not Applicable	A-18463	Collar, Shaft, with Set Screw, 3/8"	VE23	EA
				
Not Applicable	EE301300-1V	Pre-Take-Up/Overfeed Assembly, Male, without Fixing Ring, Volkmann Type	VE11	EA
				
Not Applicable	EE301300V	Pre-Take-Up/Overfeed Assembly, Male Half and Fixing Ring, Volkmann Type	VE11	EA
				

<b>OEM Part #</b>	<b>Epic No.</b>	<b>Description</b>	<b>Image</b>	<b>Page</b>	
Not Applicable	EE301301V	Shell Only, Pre-Take-Up/Overfeed, 24 Flute Chrome		VE11	EA
Not Applicable	EE301302V	Shell Only, Pre-Take-Up/Overfeed, 24 Flute Ceramic Coated		VE11	EA
Not Applicable	EE301303V	Pre-Take-Up/Overfeed Assembly, 24 Flute Chrome "Epic Type"		VE11	EA
Not Applicable	EE301304V	Pre-Take-Up/Overfeed Assembly, 24 Flute Ceramic "Epic-Type"		VE11	EA
Not Applicable	EE301305V	Shell Only, Pre-Take-Up/Overfeed, 31 Flute Chrome		VE11	EA
Not Applicable	EE301306V	Shell Only, Pre-Take-Up/Overfeed, 31 Flute Ceramic		VE11	EA
Not Applicable	EE301308V	Pre-Take-Up/Overfeed Assembly, 31 Flute Chrome "Epic Type"		VE11	EA
Not Applicable	EE301309V	Pre-Take-Up/Overfeed, Male Half, without Hub, "Epic" Type			EA
Not Applicable	EE301310V	Pre-Take-Up/Overfeed, Female Half		VE11	EA



<b>OEM Part #</b>	<b>Epic No.</b>	<b>Description</b>	<b>Image</b>	<b>Page</b>	
Not Applicable	EE301311V	Pre-Take-Up/Overfeed Assembly, 31 Flute Ceramic "Epic Type"		VE11	EA
Not Applicable	EE301316V	Spring, Pre-Take-Up/Overfeed Plate		VE11	EA
Not Applicable	EE301318V	Collar, Locking with Set Screw		VE11	EA
Not Applicable	EE301319V	Ring, Fixing, for Pre-Take-Up/Overfeed Assembly		VE11	EA
Not Applicable	EE301320V	Pre-Take-Up/Overfeed Male Half, Volkmann Type		VE11	EA
Not Applicable	EE301321V	Pre-Take-Up/Overfeed Assembly, 24 Flute Chrome "Volkmann Type" , without Locking Collar		VE11	EA
Not Applicable	EE301322V	Pre-Take-Up/Overfeed Assembly, 24 Flute Ceramic "Volkmann Type" without Locking Collar		VE11	EA
Not Applicable	EE301323V	Pre-Take-Up/Overfeed Assembly , 31 Flute Chrome "Volkmann-Type" without Locking Collar		VE11	EA
Not Applicable	EE301324V	Pre-Take-Up/Overfeed Assembly, 31 Flute Ceramic "Volkmann Type" without Locking Collar		VE11	EA

EE is an Epic trademark designating Epic parts

Verdol is a trademark of Rieter/ ICBT

© Epic Enterprises, April 2009

Epic products are intended as replacements for worn or damaged parts in OEM products. OEM Part numbers in (parenthesis) indicate either 1) Improved design 2) the part serves the same function as the OEM part, but may differ from the OEM design, or 3) it is a component of an assembly where no OEM reference number is available, or 4) it is a repair service for the referenced OEM part.









<b>OEM Part #</b>	<b>Epic No.</b>	<b>Description</b>	<b>Page</b>	
Not Applicable	EE301325V	Pre-Take-Up/Overfeed Assembly, 24 Flute Chrome "Volkman Type" with Locking Collar	VE11	EA
				
Not Applicable	EE301326V	Pre-Take-Up/Overfeed Assembly, 24 Flute Ceramic "Volkman Type" with Locking Collar	VE11	EA
				
Not Applicable	EE301327V	Pre-Take-Up/Overfeed Assembly, 31 Flute Ceramic "Volkman Type" with Locking Collar	VE11	EA
				
Not Applicable	EE301328V	Pre-Take-Up/Overfeed Assembly, Volkman Type, With Locking Collar, Without Shells		EA
				
Not Applicable	EE301329V	Pre-Take-Up/Overfeed, Male & Female Halves Only, Volkman Type	VE11	EA
				
Not Applicable	EE301330V	Pre-Take-Up/Overfeed Assembly, Male Half and Fixing Ring, Volkman Type		EA
				
Not Applicable	EE302190	Pad, Foam, Lined, 237mm OD X 67.75mm ID X 51mm Thick, Gray (9 1/3" X 2 33/50" X 2")	VE07	EA
Not Applicable	EE302523	Nylon Cylinder Plug, Standard, With O-Ring		EA
				
Not Applicable	EE302546	Guard, Spindle Yarn	VE06	EA
				

<b>OEM Part #</b>	<b>Epic No.</b>	<b>Description</b>	<b>Page</b>
Not Applicable	EE302951	Rework, Snap Ring Groove for R Axle	EA
			
Not Applicable	EE302954	Checker, Housing without Dial Indicator	EA
			
Not Applicable	EE302955	Gauge and Stand, Housing Height, with Dial Indicator	EA
			
Not Applicable	EE302956	Checker, Housing with Dial Indicator	EA
			
Not Applicable	EE303260-2	Pot, Stainless Side, 290H240, for 450 (2.062" Hole)	EA
			VE07
Not Applicable	EE303614A	Balloon Centering Guide Assembly, Without Balloon Guide (for 8mm Rod)	EA
Not Applicable	EE303614B	Balloon Centering Guide Assembly, Complete with Ceramic Guide Assembly (8mm Rod)	EA
Not Applicable	EE304120-2	Bearing, Upper Oblique, 16004C3, SKF	EA
			VE01 VE01A
Not Applicable	EE304296	Bearing, Ball, 6003ZZC3	EA
			

<b>OEM Part #</b>	<b>Epic No.</b>	<b>Description</b>	<b>Page</b>	
Not Applicable	EE304304	Bearing, Ball, 6204ZZC3, with 2 Metal Shields		EA
				
Not Applicable	EE304780	Cover, Intermediate Small Overfeed(A-18174) (400mm)	VE11	EA
				
Not Applicable	EE304820V	Grease, Spindle Bearing, Kluber, 1 Kilogram (Not Shown)	VE01	EA
				
Not Applicable	EE304821	Grease, R Axle Spline, Kluber (1 Kilogram) (Not Shown)	VE01	EA
				
Not Applicable	EE304822	Loctite RC/609-21, 10 ml. Bottle for securing spindle bearings (Not Shown)	VE01	EA
				
Not Applicable	EE304823	Grease, R Axle Spline (30CC Syringe) (Not Shown)	VE01	EA
				
Not Applicable	EE305534	Magnet (For Inner and Outer)	VE05A	EA
				
Not Applicable	EE305543	Brackets and Hardware to Mount Dial Storage Tensor to Verdol 400 Creel (does not include dial storage tensor or roller assembly)	VE14	EA
				
Not Applicable	EE305543-1	Brackets and Hardware to Mount Dial Storage Tensor to Verdol 400 Creel (with roller, without storage tensor)	VE14	EA
				





<b>OEM Part #</b>	<b>Epic No.</b>	<b>Description</b>	<b>Page</b>	
Not Applicable	EE305544	Spindle, RM, New for 260 X 175 Disc Assembly without Disc	VE18	EA
				
Not Applicable	EE305544-1	Spindle, RM, New for 260 X 160 Disc Assembly without Disc	VE18	EA
				
Not Applicable	EE305546-1	RM Spindle, New, Complete with 260 X 160 Disc Assembly	VE18	EA
				
Not Applicable	EE309022V	Tool, Bearing Housing Grease Packer		EA
				
Not Applicable	EE309024	Stabilizer Checker with Dial Indicator		EA
				
Not Applicable	EE309024-1	Stabilizer Checker without Dial Indicator		EA
				
Not Applicable	EE309035	Top Bearing Housing Assembly for EpiMag SA-II		EA
				
Not Applicable	EE309053	Seal for Traverse Rod at Gearbox, 5/8"	VE10	EA
				
Not Applicable	EE309060	Grease, Spindle Bearing, Kluber, 25 Kilograms, LDS-18A		EA
				







<b>OEM Part #</b>	<b>Epic No.</b>	<b>Description</b>	<b>Page</b>	
Not Applicable	EE309068	Eyelet, Flanged, White	VE21	EA 
Not Applicable	EE309072-00	Capsule, Tension #00 for Verdol	VE07	EA 
Not Applicable	EE309074	Rebuild Epic or ICBT Storage Tensor	VE21	EA 
Not Applicable	EE309107	Spindle, Rebuild Customer Verdol N CONTACT EPIC FOR PRICING	VE04	EA
Not Applicable	EE309122	Spindle Assembly, ICBT N, with Upper Bearing Housing Assembly, without Spindle Disc Assembly (FOR EXCHANGE)	VE20	EA 
Not Applicable	EE309124	Repair Threading Channel with 10mm Stainless Steel Tube and Rebalance; 260 X 175mm Disc Assembly, ICBT N and Verdol RM & F44	VE18 VE19 VE20	EA 
Not Applicable	EE309135	Polish Customer's Verdol/ICBT 260mm Stainless Steel Spindle Disc	VE19	EA 
Not Applicable	EE309140	Tool, Torque, for Verdol Pot Base Shell (EE303420)	VE07	EA 
Not Applicable	EE320000	EpiMag Stabilization Kit with Cutter (Complete Inner & Outer) With Anti- Wrap Device	VE05A	EA



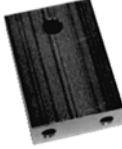

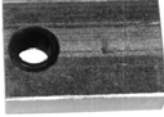



<b>OEM Part #</b>	<b>Epic No.</b>	<b>Description</b>	<b>Page</b>	
Not Applicable	EE320000-1	EpiMag Stabilization Kit with Cutter (Complete Inner & Outer) Without Anti- Wrap Device	VE05A	EA
Not Applicable	EE320001	Traverse System 120 Position for Model 400 Verdol	VE10	EA
				
Not Applicable	EE320002	Traverse System 96 Position for Model 400 Verdol	VE10	EA
				
Not Applicable	EE320003	Traverse System 84 Position for 500 Gauge Verdol	VE10	EA
				
Not Applicable	EE330602	Screw, Hex Head Cap, 10 X 40	VE10	EA
				
Not Applicable	EE331218	Screw, Hex Socket Flat Point Set, 8X16mm (Used with EE380078 Package Centering Adaptor)	VE12	EA
				
Not Applicable	EE340013	Guard, Spindle Yarn Choke, 120MM OD (For Solid Disc Only)	VE05A VE06	EA
				
Not Applicable	EE340014	Pocket, Outside Magnet, for EpiMag (Without Magnets)	VE05A	EA
				
Not Applicable	EE340015	Pocket, Inside Magnet, for EpiMag (Without Magnets)	VE05A	EA
				

<b>OEM Part #</b>	<b>Epic No.</b>	<b>Description</b>	<b>Page</b>	
Not Applicable	EE340016	Cone, EpiMag Magnet Mounting	VE05A	EA
				
Not Applicable	EE340018	Anti-Wrap Device, S & Z, Heavy Duty for EpiMag	VE05A	EA
				
Not Applicable	EE340019	Magnetic Stabilization Assembly, Outer, for EpiMag SAll/SAlII (Without Anti-Wrap Device)	VE05A	EA
				
Not Applicable	EE340019-2	Magnetic Stabilization Assembly, Outer, for EpiMag SAll/SAlII (With Anti-Wrap Device)	VE05A	EA
				
Not Applicable	EE340020	Magnetic Stabilization Assembly, Inner, for EpiMag SAll/SAlII	VE05A	EA
				
Not Applicable	EE340025	Down Tube Assembly with Epic Air Deflection Device	VE23	EA
				
Not Applicable	EE340042	Dial Storage Tensor for Epic E Creel with Mounting Brackets & Hardware, without Roller	VE21	EA
				
Not Applicable	EE340042-1	Dial Storage Tensor for Epic E Creel with Mounting Brackets and Hardware, with Roller	VE21	EA
				
Not Applicable	EE340043	Dial Storage Tensor for Verdol 400 Creel with Mounting Bracket & Hardware, without Roller	VE21	EA
				











<b>OEM Part #</b>	<b>Epic No.</b>	<b>Description</b>	<b>Page</b>	
Not Applicable	EE340043-1	Dial Storage Tensor for Verdol 400 Creel with Mounting Bracket, Roller, & Hardware	VE21	EA
				
Not Applicable	EE340053-1	Spindle Assembly, ICBT N, with Upper Bearing Housing Assembly, without Spindle Disc Assembly	VE20	EA
				
Not Applicable	EE340057	Spindle Assembly, New, F44 without Disc Assembly, with Deflector for 160mm Reserve	VE19	EA
Not Applicable	EE340058	Spindle Assembly, New, F44 without Disc Assembly, with Deflector for 175mm Reserve	VE19	EA
Not Applicable	EE340059	Spindle Assembly Complete, New, F44 with 260X160 Disc Assembly, Stainless Steel	VE19	EA
Not Applicable	EE340060	Spindle Assembly Complete, New, F44 with 260X175 Disc Assembly, Stainless Steel	VE19	EA
Not Applicable	EE340068	Repair, ICBT or Verdol RM/F44 Spindle Disc Assembly, 260X175, with New Mounting Hub (EE340047) and Balance	VE18 VE19 VE20	EA
				
Not Applicable	EE380001-2	Mounting Bracket (Plastic) with small eyelet for Double Tension Device	VE13 VE14	EA
				
Not Applicable	EE380018	Base, Inside Magnet Pocket for EpiMag	VE05A	EA
				









<b>OEM Part #</b>	<b>Epic No.</b>	<b>Description</b>	<b>Page</b>	
Not Applicable	EE380029	Foam Piece for Magnet Pocket (Inner and Outer)	VE05A	EA
				
Not Applicable	EE380037	Block, End Support,for Traverse	VE10	EA
				
Not Applicable	EE380038	Rod, Traverse Guide, 10 X 365mm, Chrome Plated	VE10	EA
				
Not Applicable	EE380039	Tube, End Guide with Bushing for Traverse for 400, 5/8" Dia. X 956mm Long	VE10	EA
				
Not Applicable	EE380041	Support, Intermediate Guide,for Traverse	VE10	EA
				
Not Applicable	EE380044	Tube,Traverse Guide,16 X 1598mm, Chrome Plated for Model 400	VE10	EA
				
Not Applicable	EE380046	Top Bearing Housing Complete for EpiMag SA-III		EA
				
Not Applicable	EE380047	Housing, Top Bearing, with O-Rings for EpiMag SA-III	VE05A	EA
				
Not Applicable	EE380060	Down Tube with Ceramic Eyelet, Collars and Washers for Verdol 450	VE23	EA
				

<i>OEM Part #</i>	<i>Epic No.</i>	<i>Description</i>	<i>Page</i>	
Not Applicable	EE380061	Tube Only, Down, for Model 450 Cabler	VE23	EA
				
Not Applicable	EE380070	Plate, Latch for E Creel	VE14	EA
				
Not Applicable	EE380074	Bracket, Lower Support, for Epic Air Deflection Assembly for 450	VE23	EA
				
Not Applicable	EE380075	Air Deflection Tube Device Complete, for 450	VE23	EA
				
Not Applicable	EE380080	Tube, Cam Connecting for 500, 5/8" x 670mm	VE10	EA
				
Not Applicable	EE380081	Tube, Starting Traverse, 5/8" X 1294mm for 500	VE10	EA
				
Not Applicable	EE380082	Rod, Intermediate Traverse, 16 X 1996mm, Chrome Plated for Model 500	VE10	EA
				
Not Applicable	EE380083	Tube, End Traverse with Bushing for 500, 5/8" Dia. X 1300mm Long	VE10	EA
				
Not Applicable	EE380086	Base Shell Extension	VE07	EA
				

<b>OEM Part #</b>	<b>Epic No.</b>	<b>Description</b>	<b>Page</b>	
Not Applicable	EE380091	Block, Cam Connecting	VE10	EA
				
Not Applicable	EE380092	Rod Wiper Block Assembly RH	VE10	EA
				
Not Applicable	EE380092-1	Rod Wiper Block Assembly LH	VE10	EA
				
Not Applicable	EE380100	Coupling, Offset, Traverse Tube	VE10	EA
				
Not Applicable	EE380101	Tube, Cam Connecting Traverse for 400, 5/8" X 515mm	VE10	EA
				
Not Applicable	EE380102	Tube, Starting Traverse, 5/8" x 1933mm for 400	VE10	EA
				
Not Applicable	EE380119B	Bushing, DU, Arm	VE21	EA
				
Not Applicable	EE380121	Spring, S/S Torsion	VE21	EA
				
Not Applicable	EE380133	Bracket with Hardware to mount EE340035 Series Devices to Epic Style E Creel	VE21	EA
				









<b>OEM Part #</b>	<b>Epic No.</b>	<b>Description</b>	<b>Page</b>	
Not Applicable	EE380134	Bracket, Mounting, for Storage Tensor for Verdol and Epic Creel	VE21	EA
				
Not Applicable	EE380196	Bushing, Adaptor for Verdol Single End Up-Twisting Conversion		EA
				
Not Applicable	EE380200	Shell Only, PTU/Over Feed, 14 Flute, Open-Type, Chrome, for ICBT	VE25	EA
				
Not Applicable	EE380216	Stud, Conversion, ICBT-to-Volkmann Type for Cradle Arm		EA
				
Not Applicable	EE380228	Base Shell Extension for EE380229 Adaptor	VE28 VE28A	EA
				
Not Applicable	EE380234	Feed Bushing Adaptor for Verdol Base Shell Extension for Verdol 400, 500, 600, and ICBT	VE26	EA
				
Not Applicable	EE380235	Feed Bushing Adaptor for Base Shell Extension; for Verdol 450	VE26	EA
Not Applicable	EE380239	Bushing, 29mm, for ICBT Creel		EA
				
Not Applicable	EE401015V	Screw, Socket Head Cap, 5X12	VE20	EA
				

<b>OEM Part #</b>	<b>Epic No.</b>	<b>Description</b>	<b>Page</b>	
Not Applicable	EE401020V	Screw, Hex Socket Cup Point Set, 5X8	VE11 VE26	EA 
Not Applicable	EE401620V	Disc, Chrome Tension, for Cabler Cap and Brake	VE08 VE08A	EA 
Not Applicable	EE401661V	Disc, Ceramic, for Cabler Cap and Brake	VE08 VE08A	EA 
Not Applicable	EE401668V	Bushing, Long Traverse, 16.4X22.1X22m	VE10	EA 
Not Applicable	EE401673V	Bushing, Interior for Traverse Rod 10.4x14.1x15mm, 05-09, BA3-BA6	VE10	EA 
Not Applicable	EE401830-1V	Double Tension Device (Capsules not included)	VE13 VE14 VE15 VE16	EA 
Not Applicable	EE401834V	Nut, Plastic (Fixing Screw) 14X1.5mm	VE13	EA 
Not Applicable	EE401835-1V	Capsule, Straight Tension, Bulb Type, #0	VE13 VE26	EA 
Not Applicable	EE401836-1V	Capsule, Straight Tension, Bulb Type, #1	VE13 VE26	EA 









<b>OEM Part #</b>	<b>Epic No.</b>	<b>Description</b>		<b>Page</b>	
Not Applicable	EE401837-1V	Capsule, Straight Tension, Bulb Type, #2		VE13 VE26	EA
Not Applicable	EE401838-1V	Capsule, Straight Tension, Bulb Type, #3		VE13 VE26	EA
Not Applicable	EE401839-1V	Capsule, Straight Tension, Bulb Type, #4		VE13 VE26	EA
Not Applicable	EE401840-1V	Capsule, Straight Tension, Bulb Type, #5		VE13 VE26	EA
Not Applicable	EE401841-1V	Capsule, Straight Tension, Bulb Type, #6		VE13 VE26	EA
Not Applicable	EE401858V	Spring, Tension (Yellow)		VE08 VE08A	EA
Not Applicable	EE401859V	Spring, Tension, (Black)		VE08 VE08A	EA
Not Applicable	EE401860V	Spring, Tension , (Silver)		VE08 VE08A	EA
Not Applicable	EE401864V	Ceramic Eyelet		VE13 VE23	EA

<b>OEM Part #</b>	<b>Epic No.</b>	<b>Description</b>	<b>Page</b>	
Not Applicable	EE401874V	Bushing, Clear Urethane, for Cabler Cap Tension Device	VE08 VE08A	EA 
Not Applicable	EE401875V	Traverse Thread Guide Assembly Complete, 3.0mm , Heavy Duty	VE10	EA 
Not Applicable	EE401877V	Washer, Regular Flat, 5mm	VE08A VE10	EA 
Not Applicable	EE401878V	Traverse Thread Guide, 3.0mm with Bracket, Heavy Duty	VE10	EA 
Not Applicable	EE401924V	Ceramic, Post/Tube, Pink	VE08A	EA 
Not Applicable	EE401976V	Bearing, Ball, 6208		EA 
Not Applicable	EE401981V	Post, Flanged Ceramic Guide, for Centering Post and for Extended Bottom of Unitensor	VE08	EA 
Not Applicable	EE402300V	Cap, Tube End, 73mm (2.875")		EA 
Not Applicable	EE430210V	Screw, Socket Head Cap 5X10	VE18 VE19	EA 

















<b>OEM Part #</b>	<b>Epic No.</b>	<b>Description</b>	<b>Page</b>	
Not Applicable	EE430244V	Screw, Socket Head Cap 8X40	VE10	EA
				
Not Applicable	EE430503V	Screw, Hex Head Cap 5X10	VE10	EA
				
Not Applicable	EE430507V	Screw, Hex Head Cap 5X70	VE08A	EA
				
Not Applicable	EE431225V	Screw, Hex Socket Flat Point Set 5X8	VE11	EA
				
Not Applicable	EE431502V	Screw, Hex Socket Cup Point Set 6X10	VE10	EA
				
Not Applicable	EE431802V	Washer, Regular Lock, B, 10mm	VE10	EA
				
Not Applicable	EE432000V	Washer, Spring Wave, 6mm	VE08	EA
				
Not Applicable	EE432503V	Lockwasher, Split, 8mm	VE10	EA
				
Not Applicable	EE433502V	Nut, Nylon Insert Lock, 5mm	VE08A	EA
				

<b>OEM Part #</b>	<b>Epic No.</b>	<b>Description</b>	<b>Page</b>	
Not Applicable	EE434015V	Pin, Spring Tension 4X20	VE10	EA
				
Not Applicable	EE434205V	Ring, External Retaining, 17X1	VE19	EA
				
Not Applicable	EE434402V	Circlip, External, 4mm	VE08	EA
				
Not Applicable	EE434406V	Circlip, External, 8mm	VE16	EA
				
Not Applicable	EE435088V	O-Ring 32 X 1.5	VE05A	EA
				
Not Applicable	EE437316V	Screw, Hex Head Cap 5X80	VE08	EA
				
Not applicable	EE440008V	Single Tension Device (Capsules not included)	VE13	EA
				
Not Applicable	EE440009V	Bracket, Main Support, Heavy Duty, Traverse Guide	VE10	EA
				
Not Applicable	EE440047-2	Bracket, Standard Cabler Cap Tension Device, 3-Post	VE08A	EA
				

<b>OEM Part #</b>	<b>Epic No.</b>	<b>Description</b>	<b>Page</b>	
Not Applicable	EE440272V	Multi-Tension Device, Manual, Flat Cap, 33mm	VE26	EA
				
Not Applicable	EE480000V	Ceramic Eyelet for Double Tension Device (5.5mm)	VE13	EA
				
Not Applicable	EE480002V	Top Numbering Strip for Tension Device	VE13	EA
				
Not Applicable	EE480003V	Bottom Numbering Strip for Tension Device	VE13	EA
				
Not Applicable	EE480004V	Friction Cuff only for Epic Deflection Tube	VE23	EA
				
Not Applicable	EE480006V	Hex Jam Nut (used on Single Tension Device)	VE13	EA
				
Not Applicable	EE480016V	Washer, Foam Rubber, for Cabler Cap Tension Device	VE08 VE08A	EA
				
Not Applicable	EE480018V	Clamp Piece, Mounting, for Heavy Duty Traverse Bracket	VE10	EA
				
Not Applicable	EE480055-2V	Coupling, Traverse Rod, with 2 Holes and 4mm Pins	VE10	EA
				

<b>OEM Part #</b>	<b>Epic No.</b>	<b>Description</b>		<b>Page</b>	
Not Applicable	EE480080-3V	Feed Bushing, 8" Manual		VE26	EA
Not Applicable	EE480143V	Ring (Spacer), Distance for Cabler Cap Tension Device		VE08 VE08A	EA
Not Applicable	EE480183V	Bushing, Threaded Brass		VE26	EA
Not Applicable	EE480247V	Back Plate Assembly for UniTensor		VE08	EA
Not Applicable	EE480424V	Insert, Nylon Locking, for UniTensor		VE08	EA
Not Applicable	EE480436V	Wrench, Manual Nut Driver, for UniTensor		VE08	EA
Not Applicable	EE480747V	Ring, Centering, 73mm, for Manual Multi-Tension Device		VE26	EA
Not Applicable	EE481535V	Stud, UniTensor Adjusting, for Clear OEM Cabler Cap		VE08	EA
Not Applicable	EE980071	Package Support Only, for Pot, ICBT and Verdol (DT2)		VE28A	EA

<b>OEM Part #</b>	<b>Epic No.</b>	<b>Description</b>	<b>Page</b>	
Not Applicable	EE980072	Package Support Assembly, for Pot, ICBT (DT2)	VE28A	EA
				
Not Applicable	MV-1011-CR	Latch, C Creel Hardened Safety		EA
				
Not Applicable	MV-1014CR	Spring, C Creel Small Latch	VE15	EA
				
Not Applicable	MV-1019-CR	Spring, C Creel Extension	VE15	EA
				
Not Applicable	MV-1020CR	EyeBolt, C Creel	VE15	EA
				
Not Applicable	MV-1021CR	C Creel Package Arm Assembly including Spring Bracket (Welded on Arm), U-Bolt Plate and Oval Handle	VE15	EA
Not Applicable	MV-1023CR	Bracket, C Creel Spring (Welded on Arm)		EA
Not Applicable	MV-1026CR	U-Bolt, C Creel	VE15	EA
				
Not Applicable	MV-1027CR	Holder, C Creel Yarn Guide	VE15	EA
				

<b>OEM Part #</b>	<b>Epic No.</b>	<b>Description</b>	<b>Page</b>	
Not Applicable	MV-1028CR	Holder, C Creel Hardwood Tube	VE15	EA
				
Not Applicable	MV-1029CR	Disc, C Creel Support		EA
				
Not Applicable	MV-1030CR	Pad, C Creel Foam		EA
				
Not Applicable	MV-1031CR	C Creel Assembly Complete		EA
Not Applicable	MV-1032CR	Bolt, C Creel Shoulder	VE15	EA
				
Not Applicable	MV-7100-62	Ring, C Creel Retaining		EA
R20PC851	EE304460	O-Ring, Top Bearing Lower	VE01 VE01A	EA
				
R24PB701	EE304500	O-Ring, Top Bearing Upper	VE01 VE01A VE05A VE18 VE19 VE20	EA
				
R26PC85LJF	EE304540	O-Ring for Spindle Housing	VE01 VE01A VE18 VE27	EA
				

EE is an Epic trademark designating Epic parts

Verdol is a trademark of Rieter/ ICBT

© Epic Enterprises, April 2009

Epic products are intended as replacements for worn or damaged parts in OEM products. OEM Part numbers in (parenthesis) indicate either 1) Improved design 2) the part serves the same function as the OEM part, but may differ from the OEM design, or 3) it is a component of an assembly where no OEM reference number is available, or 4) it is a repair service for the referenced OEM part.









<b>OEM Part #</b>	<b>Epic No.</b>	<b>Description</b>	<b>Page</b>	
R92006300	EE380161	Hub, Axle, ICBT N Spindle	VE20	EA 
R92006800	EE309115	Eyelet Assembly	VE20	EA 
(R92006800)	EE380172	Eyelet, Ceramic, for ICBT N Spindle	VE20 VE27	EA 
(R92006800)	EE380173	Guide, Two Way, Channel for ICBT N Spindle	VE20 VE27	EA 
(V962041.A01)	EE309129	Pot, Customer, Repaired, Stainless Steel Bottom, for 280mm Disc, ICBT, DT/CD	VE28 VE28A	EA 
VZ4410	EE380144-1	Plate, Upper Magnet, with Magnet & Grommet for Verdol Spindles, RM, F44, & ICBT	VE18 VE19 VE20 VE27	EA 
(VZ4435)	EE309127	Pot, Customer, Repaired, Stainless Steel Bottom, for 260mm Disc, ICBT, DT/CD	VE28 VE28A	EA 
(VZ4883)	EE380114-2A	Dial Storage Tensor	VE21	EA 
X021.084.047	EE303216	Deflector, Large, for RM, Original Type, 175mm Reserve Discs	VE18 VE19	EA 

EE is an Epic trademark designating Epic parts

Verdol is a trademark of Rieter/ ICBT

© Epic Enterprises, April 2009

Epic products are intended as replacements for worn or damaged parts in OEM products. OEM Part numbers in (parenthesis) indicate either 1) Improved design 2) the part serves the same function as the OEM part, but may differ from the OEM design, or 3) it is a component of an assembly where no OEM reference number is available, or 4) it is a repair service for the referenced OEM part.

<b>OEM Part #</b>	<b>Epic No.</b>	<b>Description</b>		<b>Page</b>	
X021.084.048	EE303217	Deflector, Small, for RM, Original Type, 160mm Reserve Discs		VE18	EA
X021084003	EE340021	Disc and Reserve Assembly, Stainless, 260 X 160mm for RM, F44 and ICBT		VE18 VE19 VE20	EA
X021084047	EE303216	Deflector, Large, for RM, Original Type, 175mm Reserve Discs		VE18 VE19	EA
X021084048	EE303217	Deflector, Small, for RM, Original Type, 160mm Reserve Discs		VE18	EA
X021084118	EE380144	Plate, Upper Magnet, with Magnets for Verdol Spindles, RM, F44, & ICBT		VE18 VE19 VE20	EA
X021190002	EE380150	Traverse Guide Bracket Assembly, ICBT			EA
X021410008	EE380020	Roller, V-Groove Assembly		VE16 VE22	EA
(X021442001)	EE380114-2A	Dial Storage Tensor		VE21	EA
X318580	EE304540	O-Ring for Spindle Housing		VE01 VE01A VE18 VE27	EA



EE is an Epic trademark designating Epic parts

Verdol is a trademark of Rieter/ ICBT

© Epic Enterprises, April 2009

Epic products are intended as replacements for worn or damaged parts in OEM products. OEM Part numbers in (parenthesis) indicate either 1) Improved design 2) the part serves the same function as the OEM part, but may differ from the OEM design, or 3) it is a component of an assembly where no OEM reference number is available, or 4) it is a repair service for the referenced OEM part.



<b>OEM Part #</b>	<b>Epic No.</b>	<b>Description</b>	<b>Page</b>	
(X92014701)	EE309095A	Capsule, Tension, #3, Bulb Type for ICBT	VE07	EA
				
(X92025200)	EE340048	Repair, of Threading Channel 200mm, and Balance	VE18 VE19 VE20	EA
				
X92501003	EE302040	Spring, Spindle for R, U, & G Spindle (also used for Balloon Centering Guide)	VE01 VE01A VE09 VE18 VE19	EA
				
ZU4	EE303820	Washer, Regular Flat, 4mm	VE01	EA
			